

Arco

TA4_6

REVERSE CANTILEVER CHAIR SPECIFICATION

The Reverse Cantilever chair has been designed specifically for its use in educational environments.

- Easily stackable on tables for cleaning
- Conforms to BS EN 1729: Part 1& 2 - Strength, Stability and Ergonomics
- 100% Recyclable
- Fire Resistant
- Antimicrobial
- Stackable up to 6 high
- Easy to clean and tested for use with chlorine based cleaners
- 25mm diameter frame
- 5 year guarantee

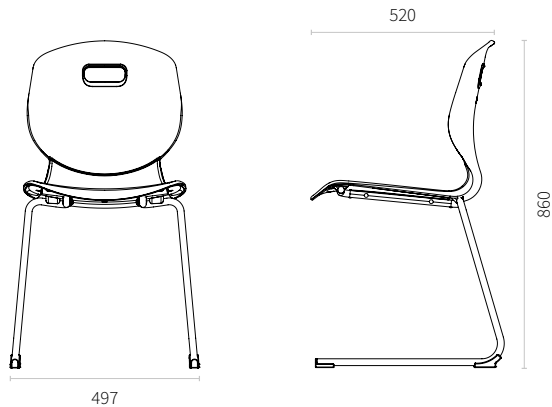

DOWNLOAD
CAD
MODELS

DOWNLOAD
PRODUCT
IMAGES



SHELL COLOURS



FRAME COLOURS



SKU	TA4_6
PRODUCT NAME	REVERSE CANTILEVER
COLOUR	Marigold / Coral / Grape / Forest / Steel Blue / Anthracite
MATERIAL	PP1100 + 4% Glass Fibre
BASE/FRAME MATERIAL	Powder Coated Steel
CERTIFICATIONS	Conforms to BS EN 1729 Part 1 & 2 Antimicrobial
FIRE RET LEVEL	UL94 V-2
COMPONENT GUARANTEE	5 Years
USAGE RECOMMENDED	8 Hours
WEIGHT TOLERANCE	115kg
GROSS WEIGHT	N/A
NETT WEIGHT	4.2kg
BOXED VOLUME	N/A
EFFECTIVE VOLUME	N/A
BOXED WIDTH	N/A
BOXED DEPTH	N/A
BOXED HEIGHT	N/A

PRODUCT WIDTH	497
PRODUCT DEPTH	520
PRODUCT HEIGHT	860
CHAIR SEAT HEIGHT	460
CHAIR SEAT WIDTH	425
CHAIR SEAT DEPTH	410
CHAIR BACK HEIGHT	425
CHAIR BACK WIDTH	405
MECHANISM TYPE	N/A
ANTI TILT MECHANISM	N/A
ARM TYPE	N/A
ARM HEIGHT	N/A
GAS LIFT COLOUR	N/A
GAS LIFT SIZE	N/A
CASTOR SIZE	N/A
FOOT TYPE	N/A
STACK QTY	6 High