

Arco

TA5_5 HIGH STOOL SPECIFICATION

The High Stool has been moulded and manufactured for use in laboratories, cafes and modernised lecture halls.

- Skid base
- Conforms to BS EN 1729: Part 1& 2 - Strength, Stability and Ergonomics
- Leg frame brace support
- 100% Recyclable
- Fire Resistant
- Antimicrobial
- Stackable up to 4 high
- Easy to clean and tested for use with chlorine based cleaners
- 5 year guarantee

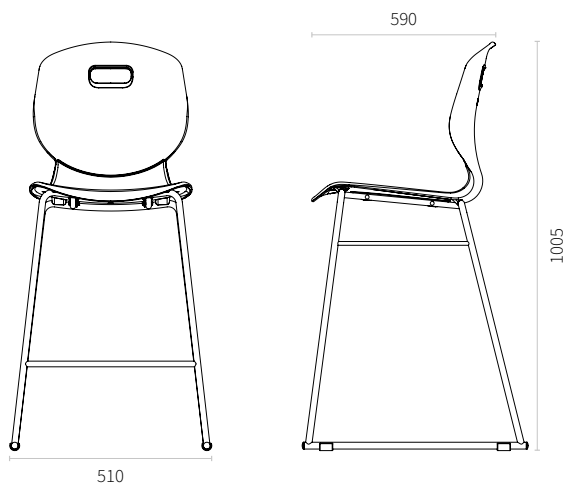

DOWNLOAD
CAD
MODELS

DOWNLOAD
PRODUCT
IMAGES



SHELL COLOURS



FRAME COLOURS



SKU	TA5_5
PRODUCT NAME	HIGH STOOL
COLOUR	Marigold / Coral / Grape / Forest / Steel Blue / Anthracite
MATERIAL	PP1100 + 4% Glass Fibre
BASE/FRAME MATERIAL	Powder Coated Steel
CERTIFICATIONS	Conforms to BS EN 1729 Part 1 & 2 Antimicrobial
FIRE RET LEVEL	UL94 V-2
COMPONENT GUARANTEE	5 Years
USAGE RECOMMENDED	8 Hours
WEIGHT TOLERANCE	115kg
GROSS WEIGHT	N/A
NETT WEIGHT	6.0kg
BOXED VOLUME	N/A
EFFECTIVE VOLUME	N/A
BOXED WIDTH	N/A
BOXED DEPTH	N/A
BOXED HEIGHT	N/A

PRODUCT WIDTH	510
PRODUCT DEPTH	590
PRODUCT HEIGHT	1005
CHAIR SEAT HEIGHT	610
CHAIR SEAT WIDTH	425
CHAIR SEAT DEPTH	410
CHAIR BACK HEIGHT	425
CHAIR BACK WIDTH	405
MECHANISM TYPE	N/A
ANTI TILT MECHANISM	N/A
ARM TYPE	N/A
ARM HEIGHT	N/A
GAS LIFT COLOUR	N/A
GAS LIFT SIZE	N/A
CASTOR SIZE	N/A
FOOT TYPE	N/A
STACK QTY	4 High