

Anson - Executive Desk & Return

AN-RET



ASSEMBLY INSTRUCTIONS

Anson
Executive Desk & Return

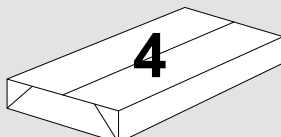

Pack 4:
1x Modesty
Panel Pack

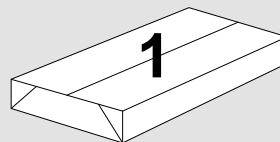

Pack 1:
1x Top Pack

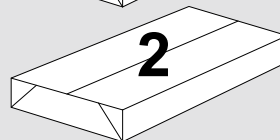

Pack 2:
1x 1000d Leg
Pack

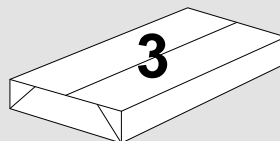

Pack 3:
1x 800d Support
Pack

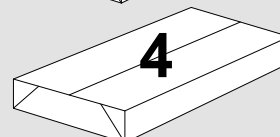

Pack 5:
1x Return Unit

TOOLS REQUIRED
FOR ASSEMBLY

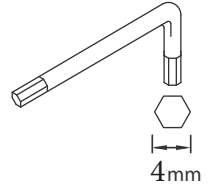
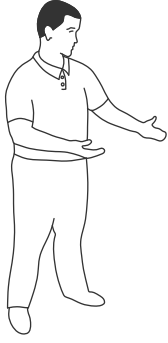

DONT STRUGGLE
2 MAN LIFT

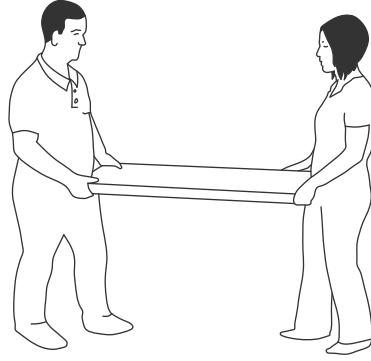
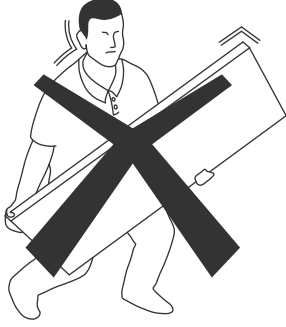

ALWAYS HANDLE
ITEMS WITH CARE

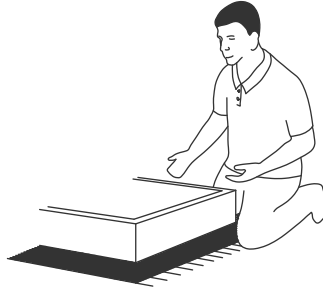
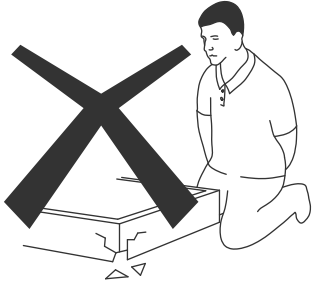

IF UNSURE CALL
FOR ASSISTANCE

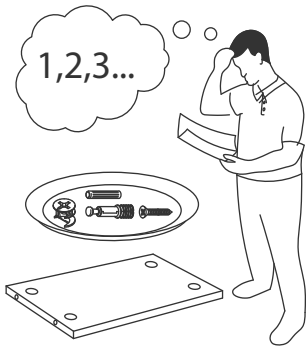

KEEP FITTINGS AWAY
FROM CHILDREN

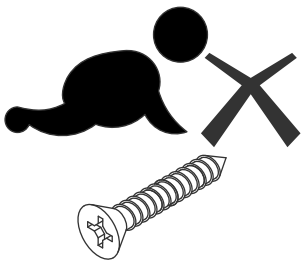



Please check that you have all the parts

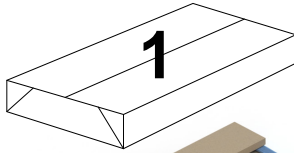

PACK 1:
2 x Top Pack

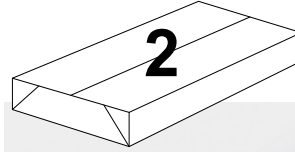

PACK 2:
1 x 1000 Leg Pack

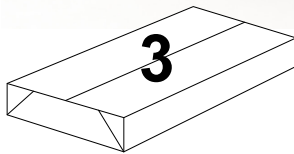
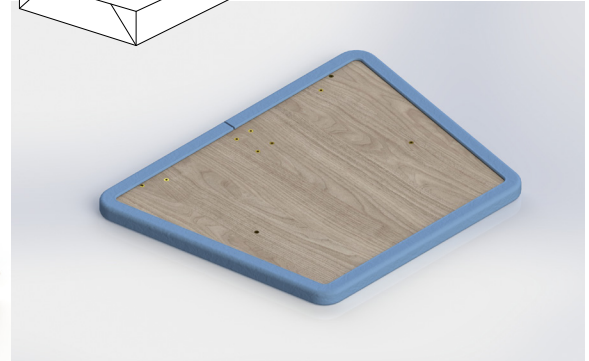
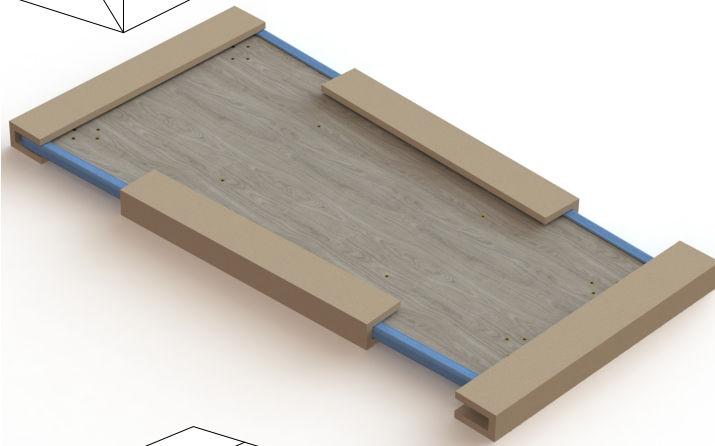

PACK 3:
1 x Support Panel Pack

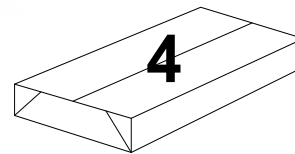

PACK 4:
1 x Modesty Panel

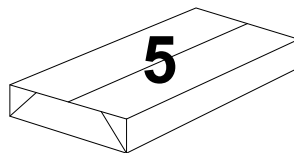

PACK 5:
1 x Return Unit

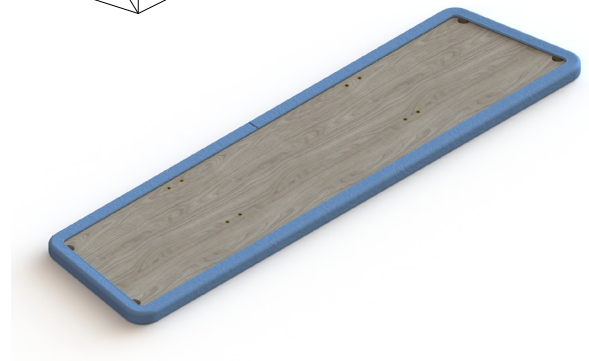

Please check that you have all the fittings

FITTINGS SUPPLIED



Connector Bolt - M6

Size 20mm **PCS 34**



CAM Fixture

Size 40mm **PCS 3**



Leg Fixing Bracket

Size 25 x 80mm **PCS 6**



Pin Fixture - M6

Size 8mm x 30mm **PCS 3**



Top Fixing Bracket

Size 200 x 200mm **PCS 2**

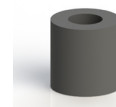

Spacer

Size 20 x 20mm **PCS 3**

ANSON EXEC DESK & RETURN ASSEMBLY

1

Step 1

Unpack your new Anson executive desk and please recycle all packaging.

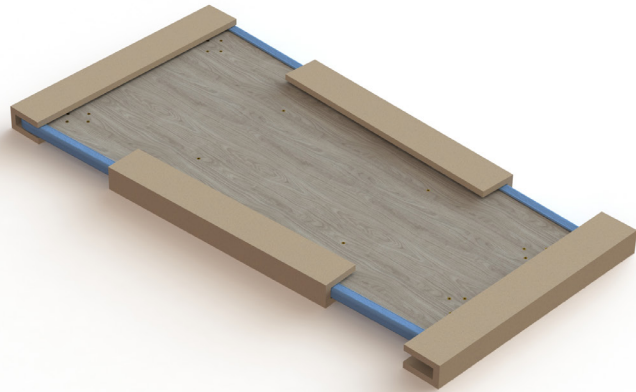

2

Step 2

Locate and attach the pins as shown and tighten turning clockwise.



3

Step 3

Locate the brackets to the fixing holes and attach using the M6 x 20mm bolts as shown.



ANSON EXEC DESK & RETURN ASSEMBLY

4

Step 4

Locate the adjustable feet as shown turning clockwise to tighten (anti-clockwise to adjust).

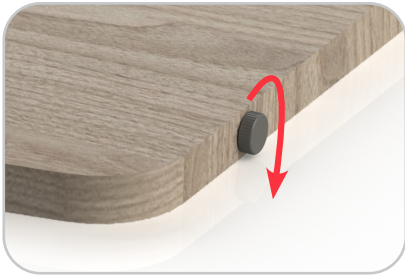

5

Step 5

Locate and attach the pins as shown and tighten turning clockwise.

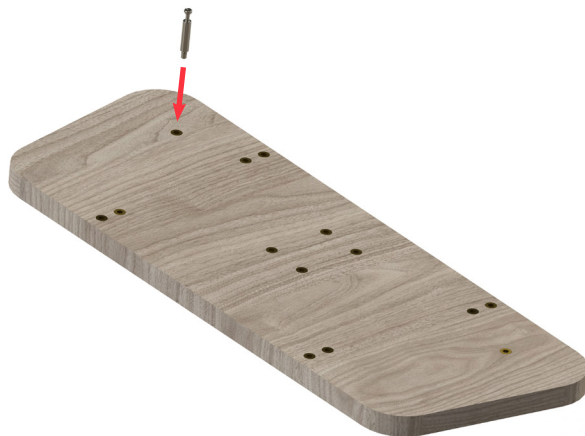

6

Step 6

Locate the brackets to the fixing holes and attach using the M6 x 20mm bolts as shown.

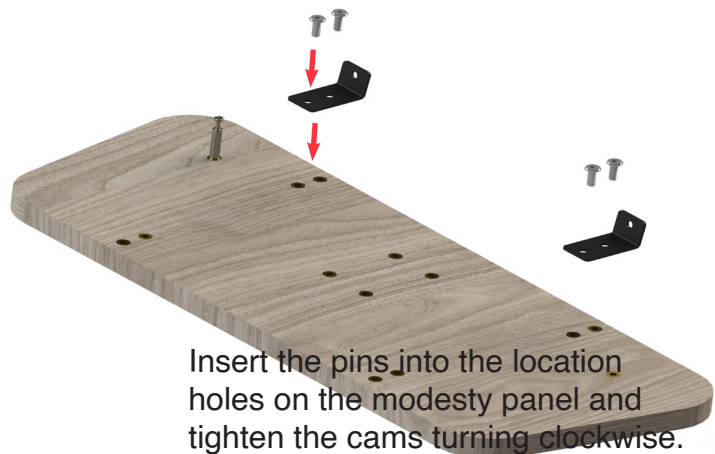

Insert the pins into the location holes on the modesty panel and tighten the cams turning clockwise.

ANSON EXEC DESK & RETURN ASSEMBLY

7

Step 7

Locate the brackets to the fixing holes and attach using the M6 x 20mm bolts as shown.



8

Step 8

Insert the large cams into the modesty panel as shown.

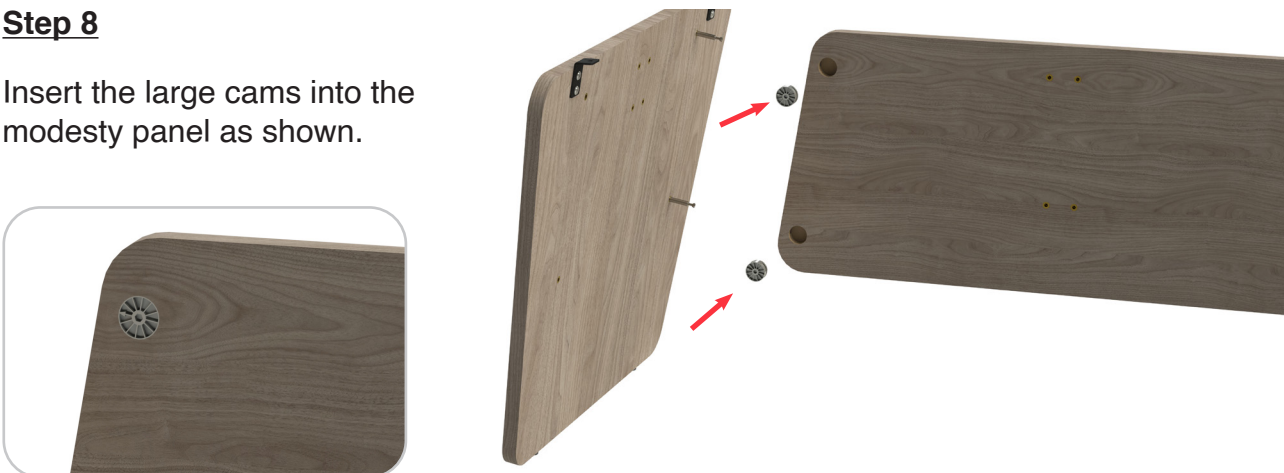

9

Step 9

Slide the spacers over the pins on the leg panel as shown.

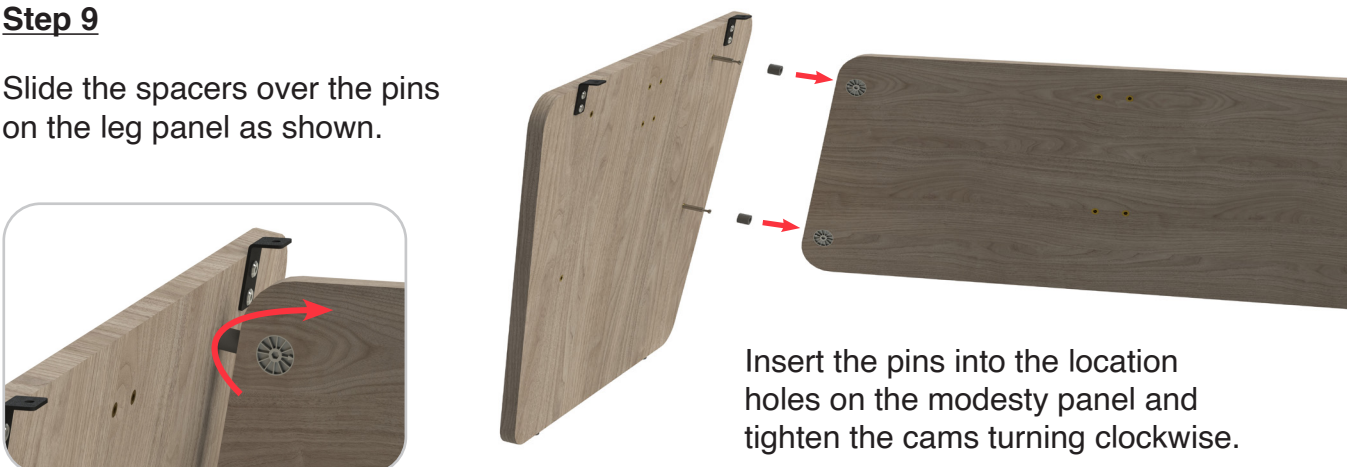

ANSON EXEC DESK & RETURN ASSEMBLY

10

Step 10

Locate the support panel as shown turning clockwise to tighten (anti-clockwise to adjust).



11

Step 11

Insert the large cams into the modesty panel as shown.

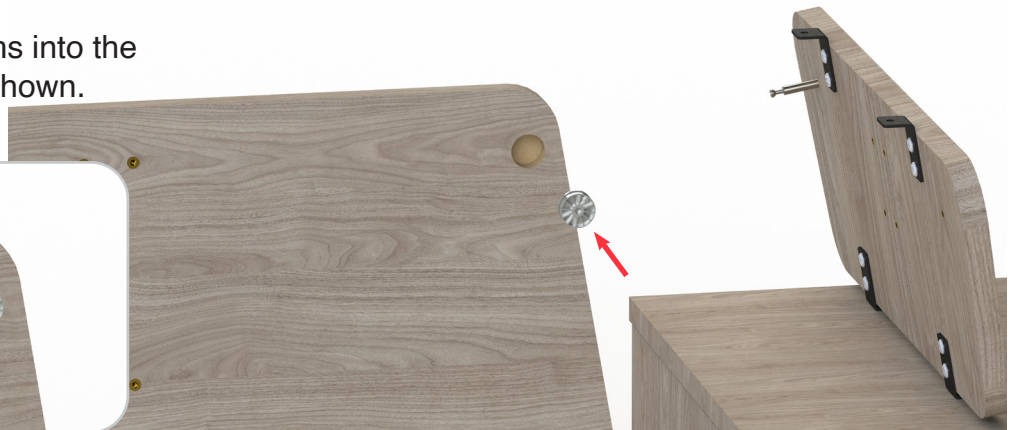

12

Step 12

Slide the spacers over the pins on the support panel as shown.

Insert the pins into the location holes on the modesty panel and tighten the cams turning clockwise.



ANSON EXEC DESK & RETURN ASSEMBLY

13

Step 13

Locate and attach the rail aligning the holes located as shown using the M6 x 20mm bolts and tighten.



14

Step 14

Locate and attach the rail aligning the holes located as shown using the M6 x 20mm bolts and tighten.



15

Step 15

Locate the modesty panel support brackets to the fixing holes located on the rail and the modesty panel.

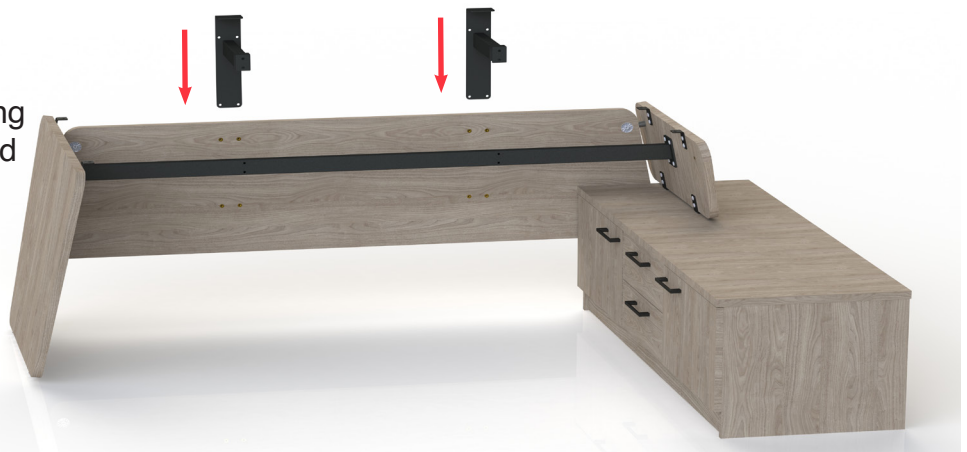

ANSON EXEC DESK & RETURN ASSEMBLY

16

Step 16

Affix the brackets as shown using the M6 x 20mm bolts.

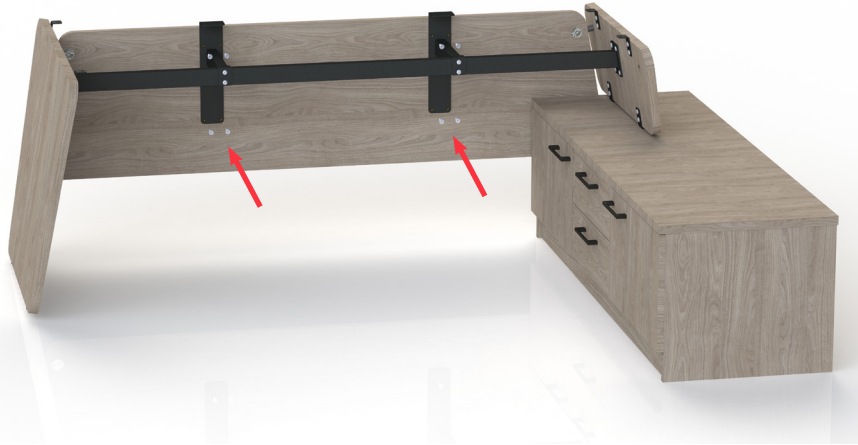
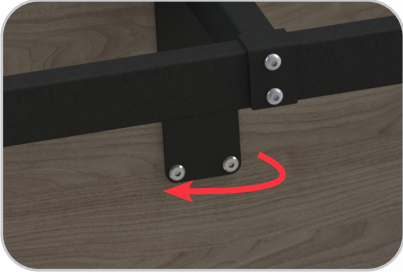

17

Step 17

Locate and attach the top panel aligning the holes on the underside of the top to the fixing brackets on the legs and modesty panel.



18

Step 18

Affix the brackets to the top panel using the M6 x 20mm bolts as shown.

