

# Anson - Rectangular Table

ANS-TBR22



## ASSEMBLY INSTRUCTIONS

Anson  
Square Table

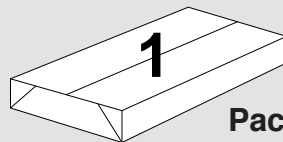

Pack 1:  
Top Pack

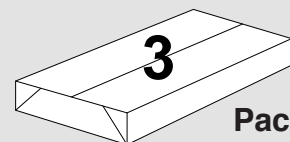

Pack 3:  
Corner Kit

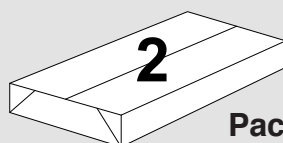

Pack 2:  
Leg Kit

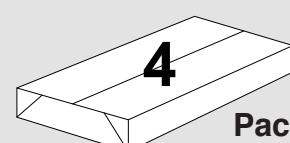

Pack 4:  
Rail Kit

TOOLS REQUIRED  
FOR ASSEMBLY

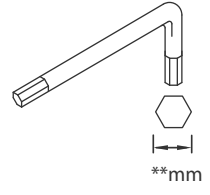
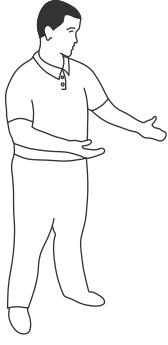

DONT STRUGGLE  
2 MAN LIFT

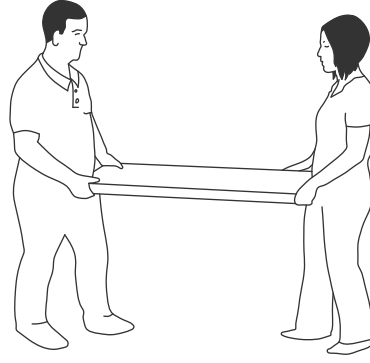
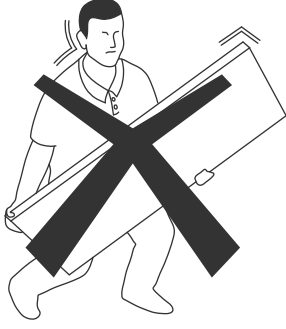

ALWAYS HANDLE  
ITEMS WITH CARE

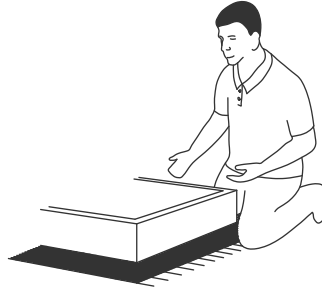
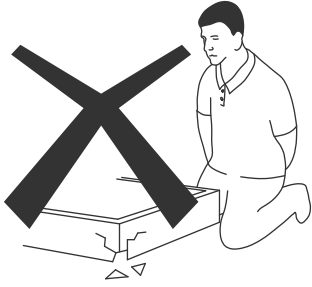

IF UNSURE CALL  
FOR ASSISTANCE

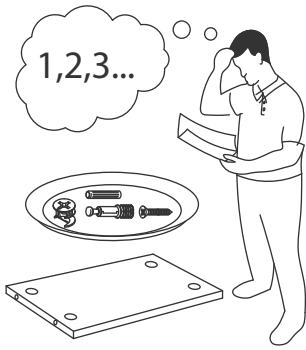

KEEP FITTINGS AWAY  
FROM CHILDREN

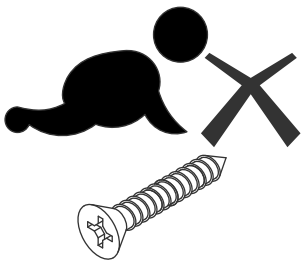



Please check that you have all the panels

ANS-TBR22-TOP

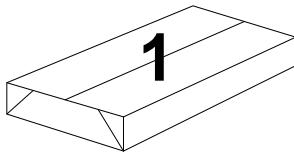

**PACK 1:**  
1 x Top Panel

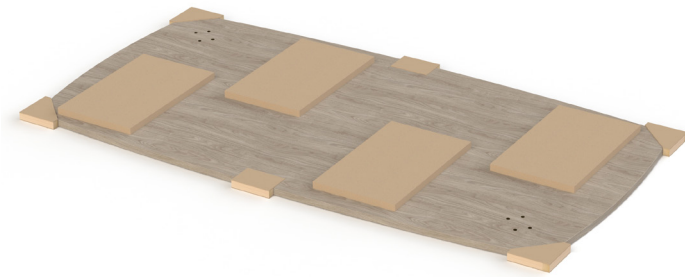

HN-LEG10-KIT

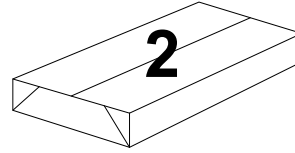

**PACK 2:**  
2 x Leg Kit



HN-CAST

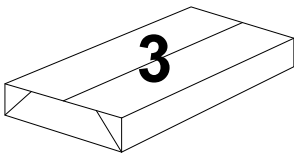

**PACK 3:**  
1 x Corner Kit



HN-RAIL-2200

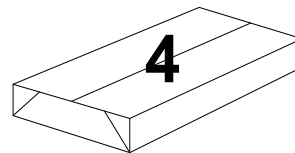

**PACK 4:**  
1 x Rail Kit



Please check that you have all the fittings

### FITTINGS SUPPLIED



M6 Connector Bolt

Size  
25mm

**PCS**  
**44**



Adjustable Foot

Size  
25mm dia.

**PCS**  
**4**

# ANSON RECTANGULAR TABLE ASSEMBLY

## 1

### Step 1

Unpack your Anson rectangular table and please recycle all packaging.

Place the top face down so that the fixing holes are face-up.

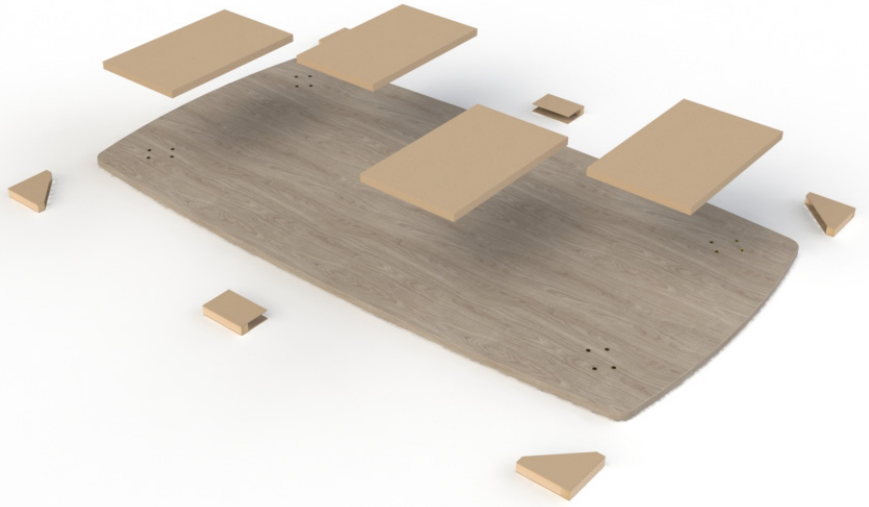

## 2

### Step 2

Assemble the legs as per 'image a' using parts from leg kit & corner kit.

Link all the legs together attaching them with the rail kit as per 'image b'

image 'a'.

image 'b'.



## 3

### Step 3

Once the frame is assembled place on the underside of the top and affix using the 16x M6 bolts as shown.

