

Anson - Deluxe Executive Desk

ANS-DED



ASSEMBLY INSTRUCTIONS

Anson
Rectangular Desk

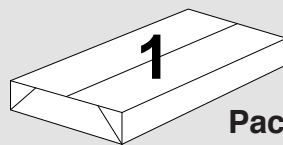

Pack 1:
Top Pack

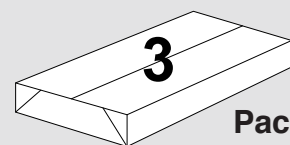

Pack 3:
Corner Kit

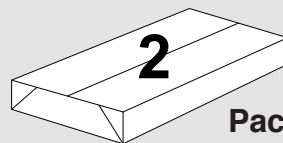

Pack 2:
Rail Kit

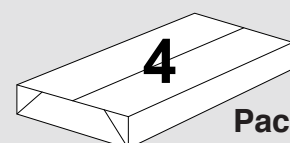

Pack 4:
1000 Leg
Kit

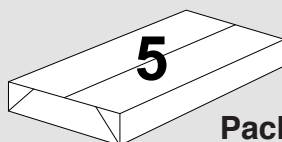

Pack 5:
600 Leg Kit

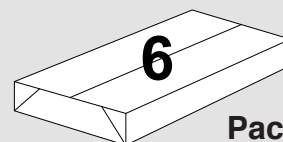

Pack 6:
Modesty Kit

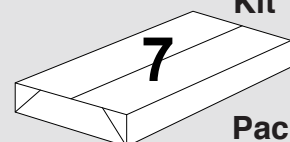

Pack 7:
Modesty
Pack

TOOLS REQUIRED
FOR ASSEMBLY

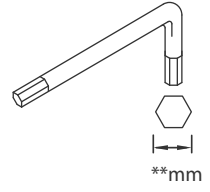

DONT STRUGGLE
2 MAN LIFT

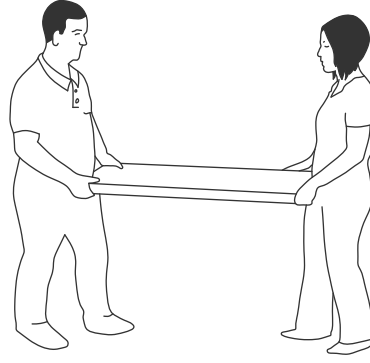
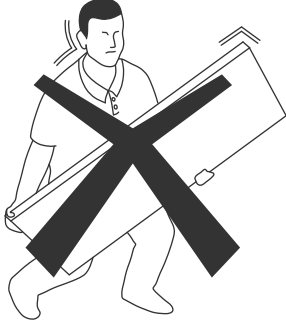

ALWAYS HANDLE
ITEMS WITH CARE

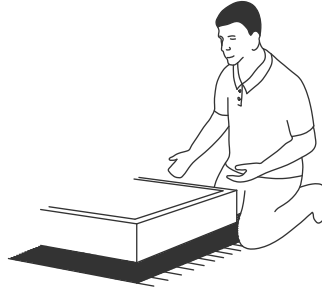
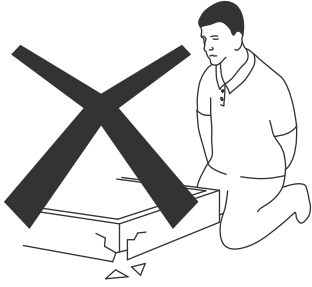

IF UNSURE CALL
FOR ASSISTANCE

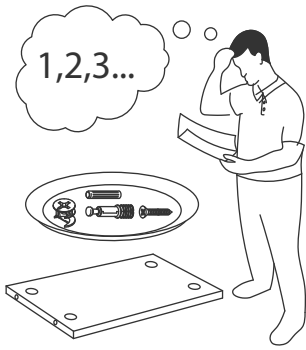

KEEP FITTINGS AWAY
FROM CHILDREN

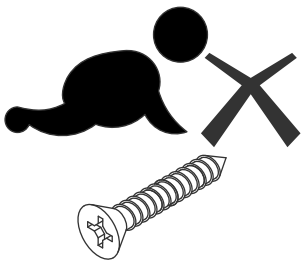



Please check that you have all the panels

ANS-EXEC-TOP

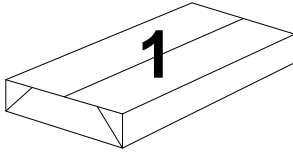

PACK 1:
1 x Top Panel

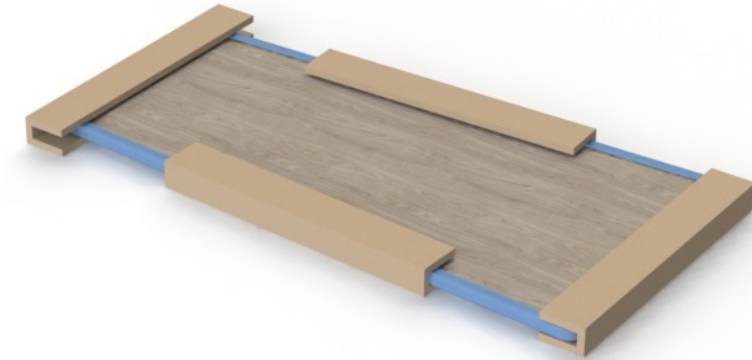

HN-RAIL-2200

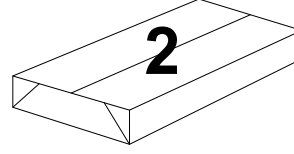

PACK 2:
1 x Rail Kit



HN-CAST

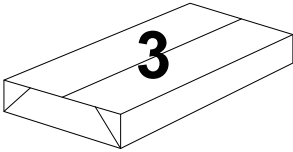

PACK 3:
1 x Corner Kit



HN-LEG10-KIT

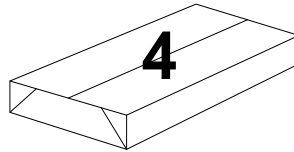

PACK 4:
1 x 1000 Leg Kit



HN-LEG6-KIT

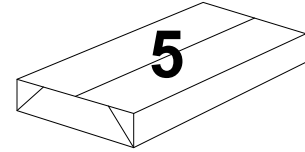

PACK 5:
1 x 600 Leg Kit



HN-MBKT-KIT

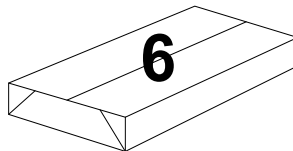

PACK 6:
1 x Modesty Kit

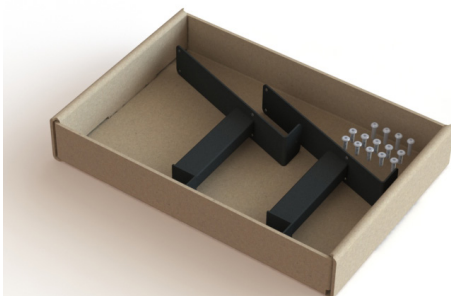

ANS-EXEC-DMOD

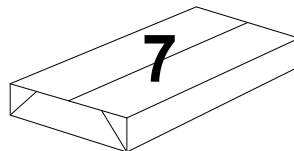

PACK 7:
1 x Modesty Panel

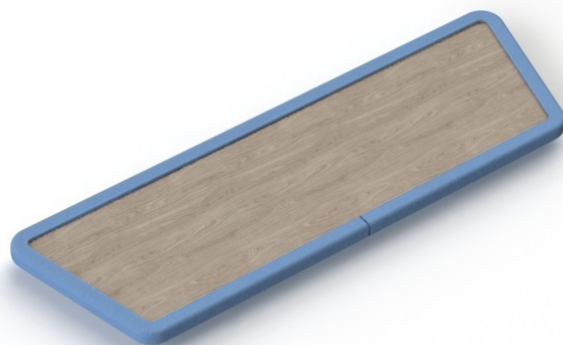



Please check that you have all the fittings

FITTINGS SUPPLIED



M6 Connector Bolt

Size
25mm

PCS
58



Adjustable Foot

Size
25mm dia.

PCS
4

1

ANSON DELUXE DESK ASSEMBLY

Step 1

Unpack your Anson rectangular desk and please recycle all packaging.

Place the top face down so that the fixing holes are face-up.

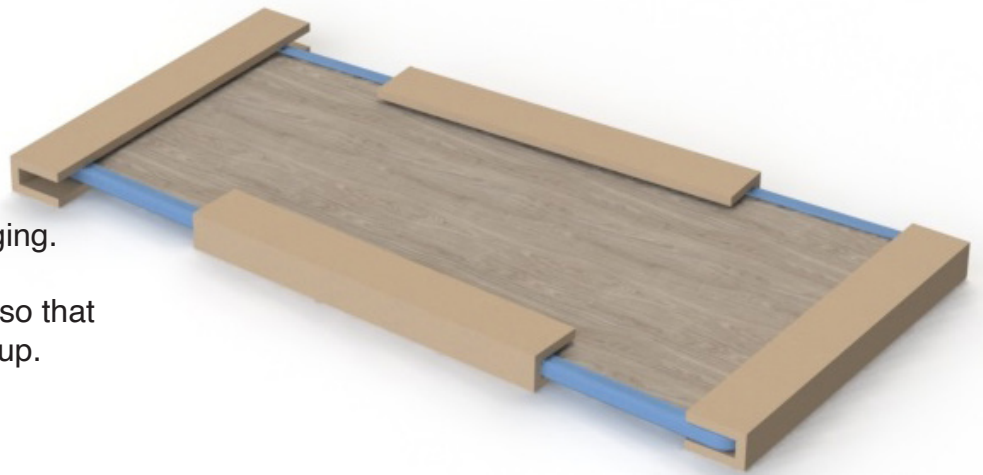

2

image 'a'.

image 'b'.

Step 2

Assemble the legs as per 'image a' using parts from both leg kit & corner kit.

Link all the legs together attaching them to the side rail as per 'image b'



ANSON DELUXE DESK ASSEMBLY

3

Step 3

Link both the end legs together attaching them with the rail kit as per image

Ensure all fixing bolts are tightened turning in a clockwise position.



4

Step 4

Once the frame is assembled place on the underside of the top and affix using the 16x M6 bolts as shown.



5

Step 5

Attach the modesty panel fixing brackets by hooking onto the cross rail and affix using the 4x M6 bolts as shown.

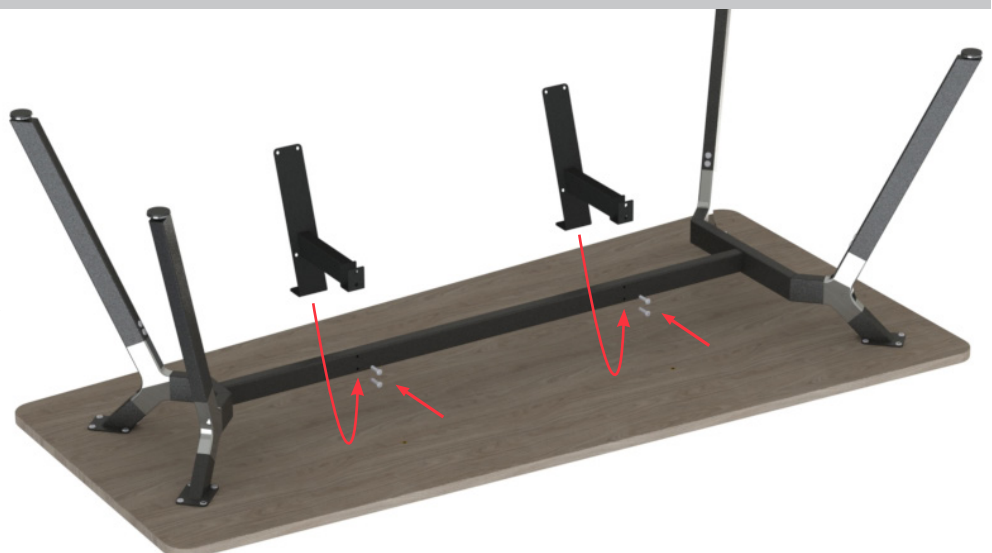

ANSON DELUXE DESK ASSEMBLY

6

Step 6

Fix the modesty brackets to the underside of the top and affix using the 2x M6 bolts.

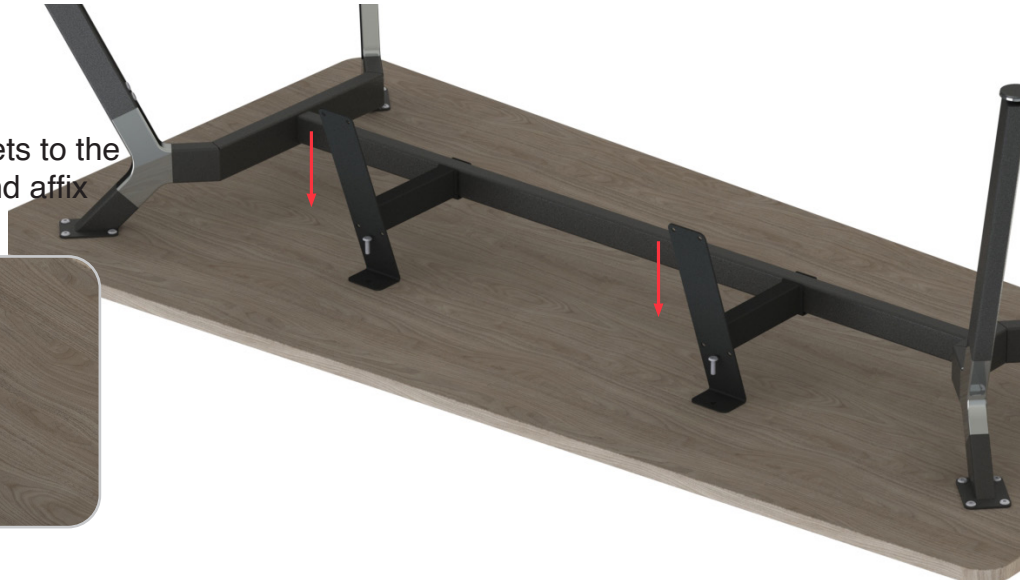
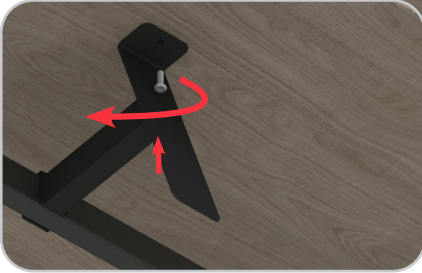

7

Step 7

Align the modesty panel to the modesty panel brackets and affix using the 8x M6 bolts as shown.



8

Step 8

Once complete ensure all fixings bolts are tightened, and with 2x person(s) lift and turnover the desk into it's upright position.

