

Here's **one** for
the **books**.

Barrister Home Tall Bookcase

Barrister Home Collection | Model 5414108

NOTE: THIS INSTRUCTION
BOOKLET CONTAINS **IMPORTANT**
SAFETY INFORMATION.

PLEASE READ AND KEEP FOR
FUTURE REFERENCE.

Table of Contents

Assembly Tools Required

Part Identification	3
Hardware Identification	4
Assembly Steps	5-16
Français	17-18
Español	19-20
Safety	21-22
Warranty	23

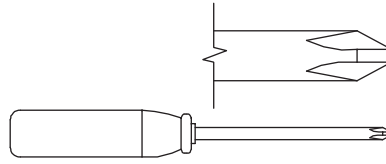

No. 2 Phillips Screwdriver
Tip Shown Actual Size

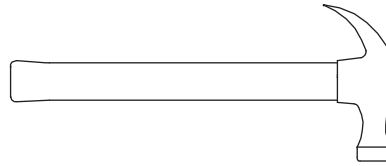

Hammer
Not actual size 😊

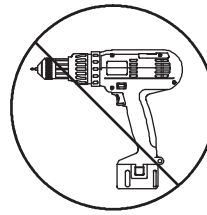

Skip the power trip.
This time.

Part Identification

Now you know
our ABCs.



While not all parts are labeled, some of the parts will have a label or an inked letter on the edge to help distinguish similar parts from each other. Use this part identification to help identify similar parts.

A	RIGHT END (1)
B	LEFT END (1)
C	UPRIGHT (1)
D	TOP (1)
E	BOTTOM (1)
F	SHELF (2)
G	PINNED SHELF (6)
H	BACK (1)
I	BASE (1)
J	LEFT BASE (1)
K	RIGHT BASE (1)
L	SHELF MOLDING (4)
M	FRONT MOLDING (1)
N	RIGHT MOLDING (1)
O	LEFT MOLDING (1)

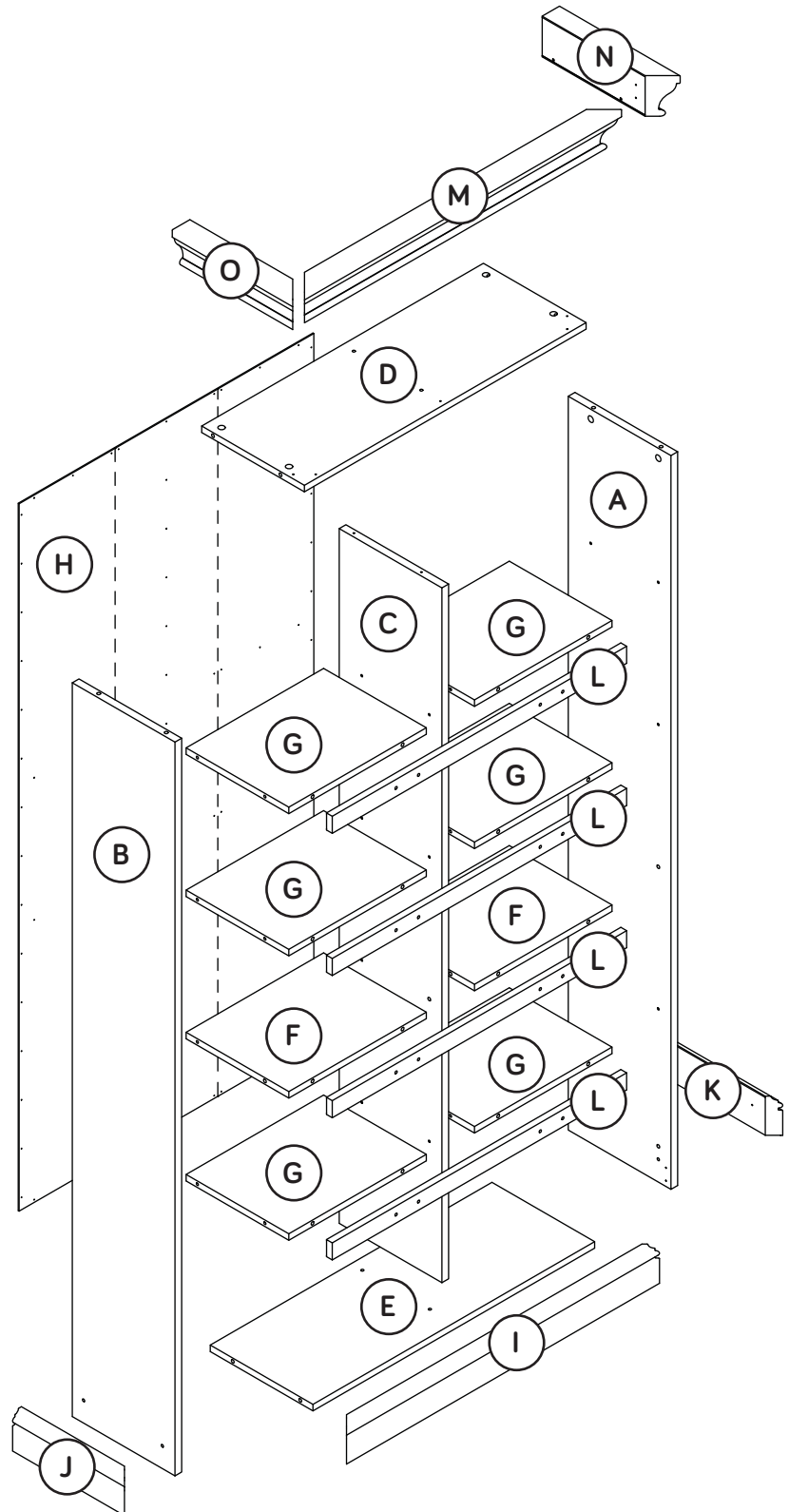

Hardware Identification

† Screws are shown actual size. You may receive extra hardware with your unit.

1F HIDDEN CAM - 32



2F CAM DOWEL - 24

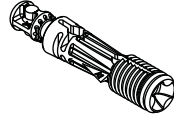

8F CAM SCREW - 8

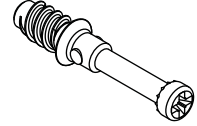

1G SAFETY BRACKET - 1

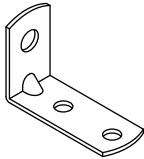

4G METAL BRACKET - 8

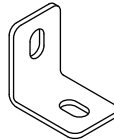

31G CORNER BRACKET - 2

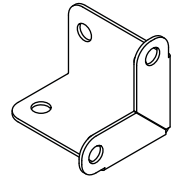

35M CARD HOLDER - 8

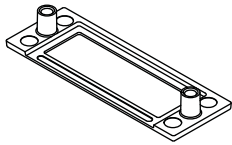

38M CARD SHEET - 1

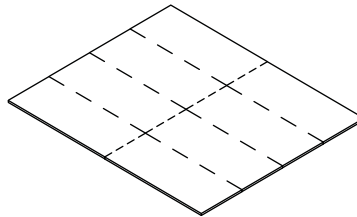

1N NAIL - 77



13P CAM COVER - 4



1R METAL PIN - 28

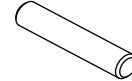

1S BLACK 9/16" LARGE HEAD SCREW - 29

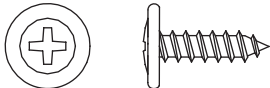

2S BLACK 1-7/8" FLAT HEAD SCREW - 5

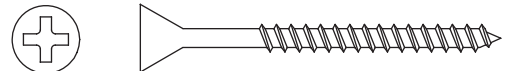

7S BLACK 1-1/4" FLAT HEAD SCREW - 4

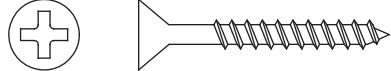

97S SILVER 3/8" MACHINE SCREW - 16

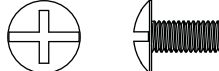

Step 1

- ✚ Assemble your unit on a carpeted floor or on the empty carton to avoid scratching your unit or the floor.
- ✚ Push thirty-two HIDDEN CAMS (1F) into the ENDS (A and B), TOP (D), BOTTOM (E), and SHELVES (F and G). Then, insert the metal end of a CAM DOWEL (2F) into each HIDDEN CAM, except the ENDS (A and B) and TOP (D).

Do not tighten the HIDDEN CAMS in this step.

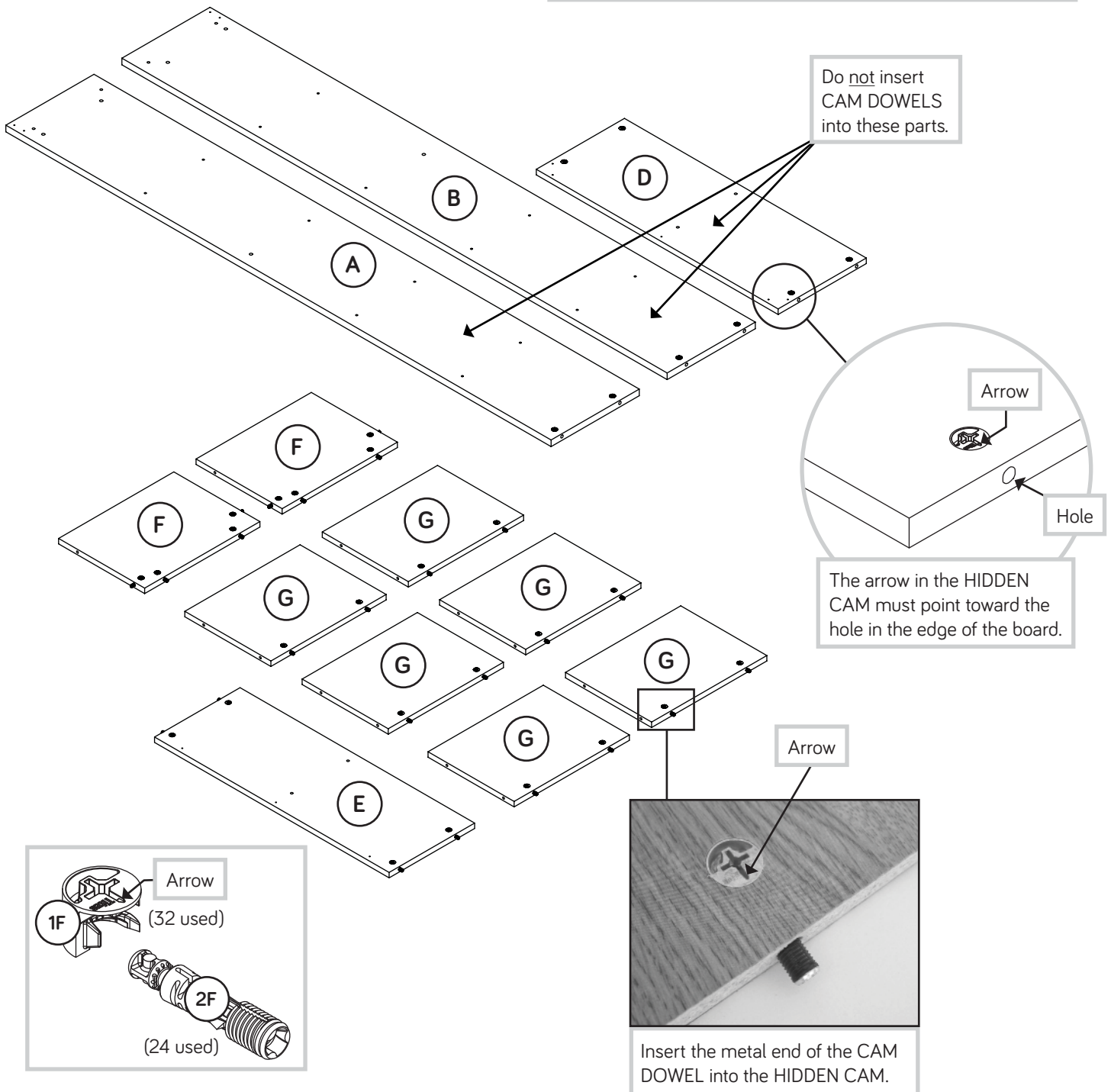

Step 2

- Turn eight CAM SCREWS (8F) into the MOLDINGS (N and O).
- Fasten the MOLDINGS (N and O) to the ENDS (A and B).
Tighten four HIDDEN CAMS.

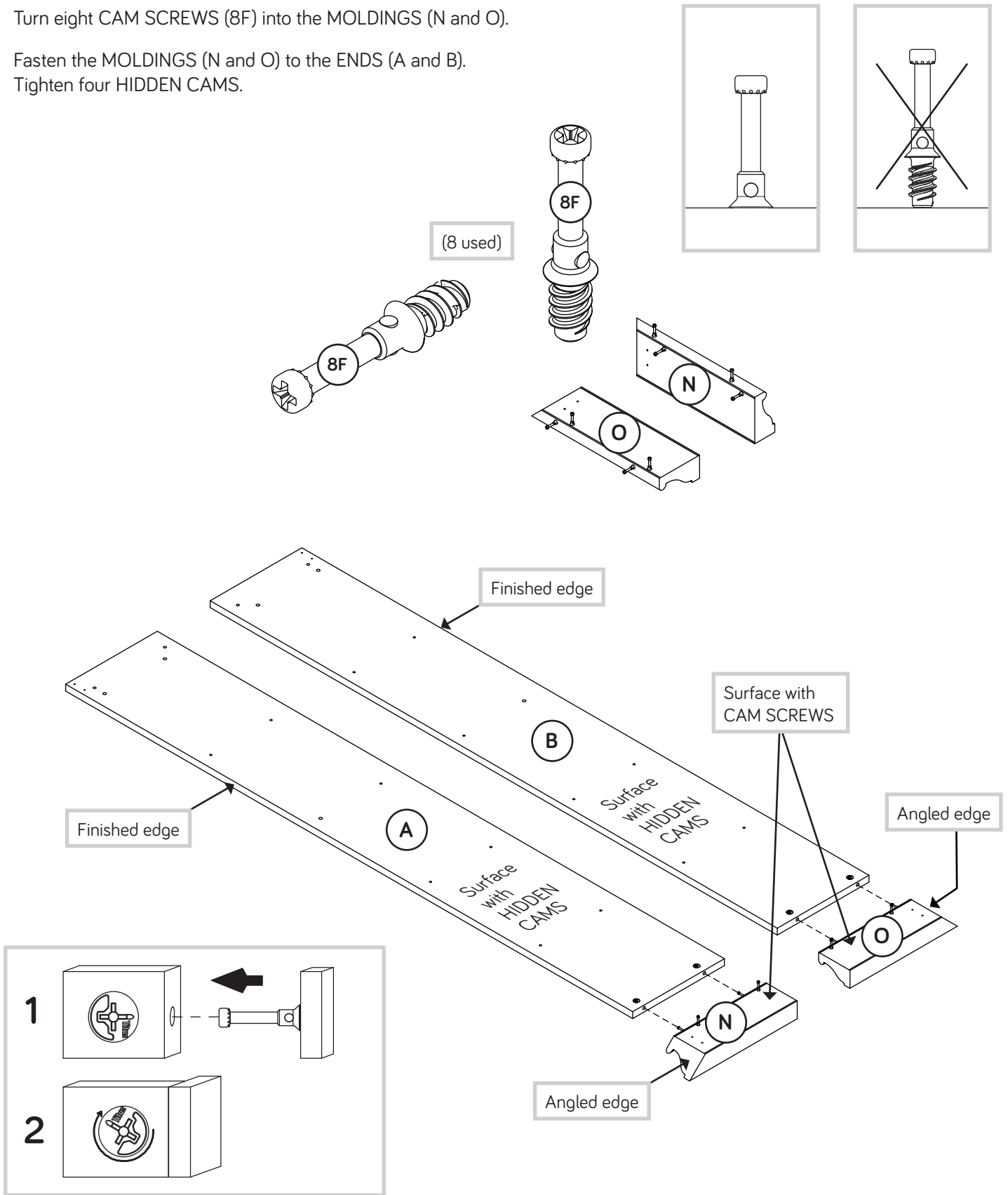

Step 3

Fasten the UPRIGHT (C) to the TOP (D). Use two BLACK 1-7/8" FLAT HEAD SCREWS (2S).

Caution

Do not stand the unit upright without the BACK fastened. The unit may collapse.

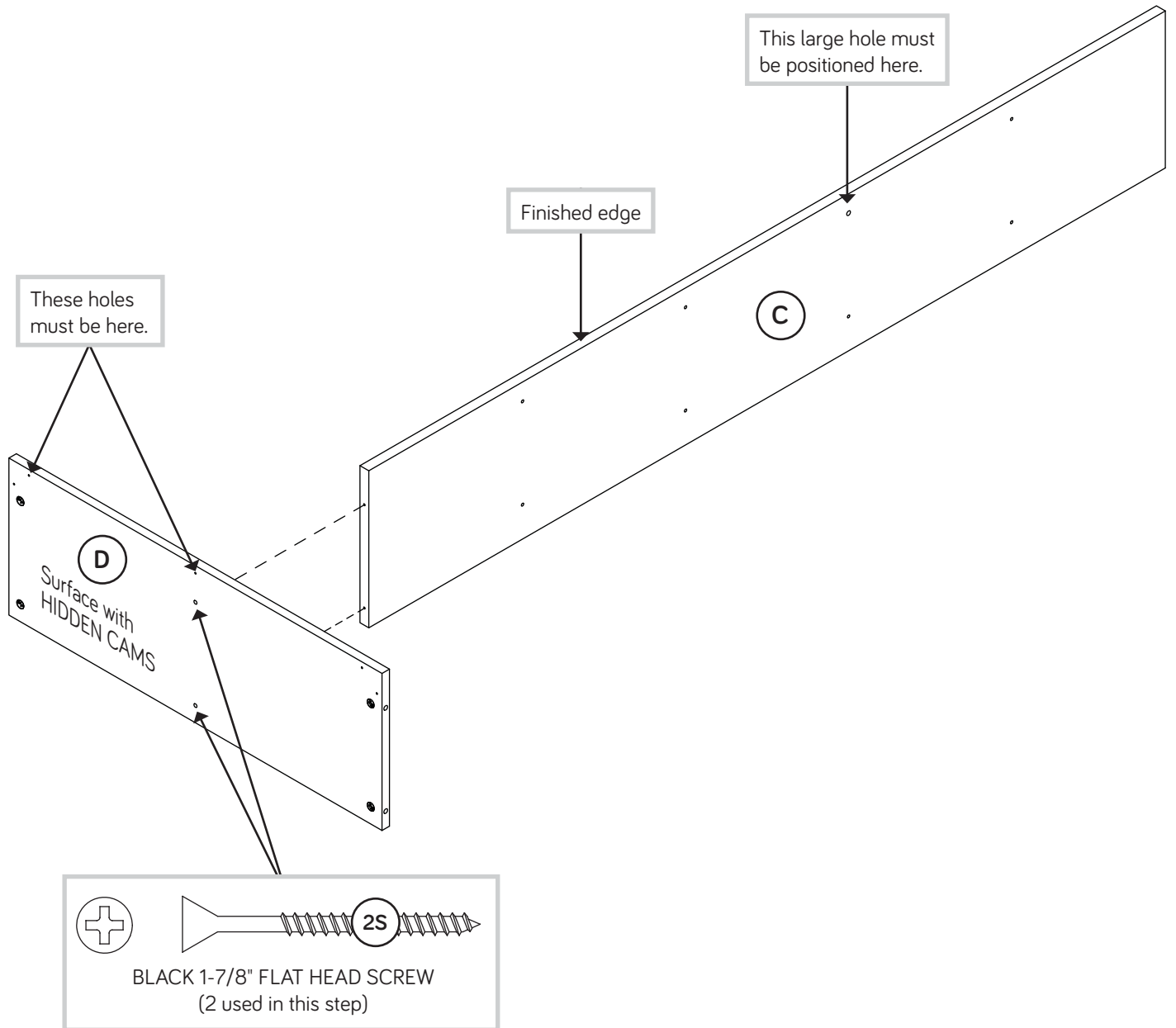

Step 4

- ✚ Insert a METAL PIN (1R) into each SHELF (F).
- ✚ Fasten the SHELVES (F) to the UPRIGHT (C). Tighten two HIDDEN CAMS.
- ✚ **NOTE:** Be sure the METAL PINS (1R) in the SHELVES (F) insert into the holes in the UPRIGHT (C).

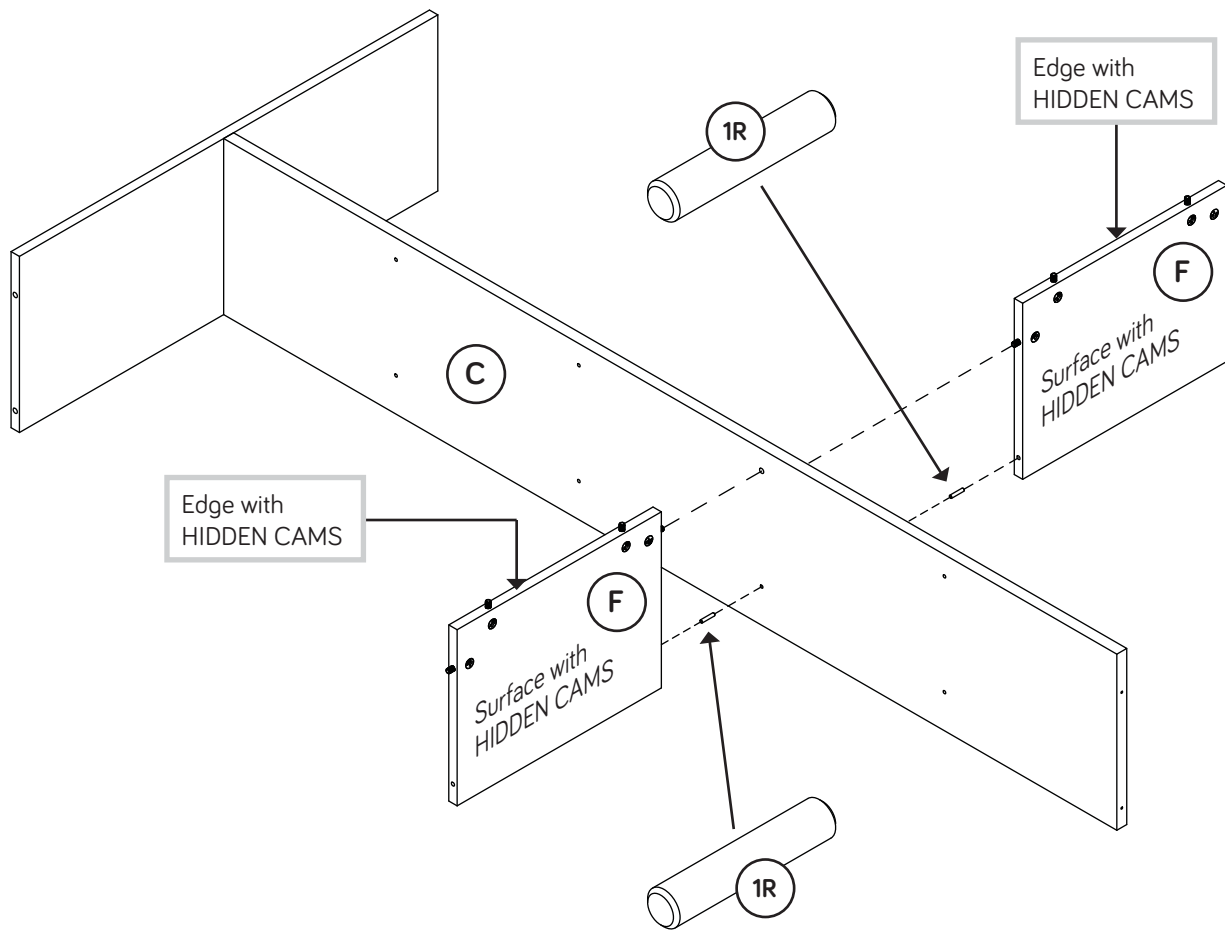

⚠ Caution

Risk of damage or injury. HIDDEN CAMS must be completely tightened. HIDDEN CAMS that are not completely tightened may loosen, and parts may separate. To completely tighten:

Start

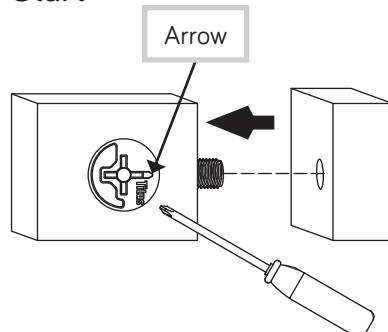

Tighten

Maximum 210 degrees

Minimum 190 degrees

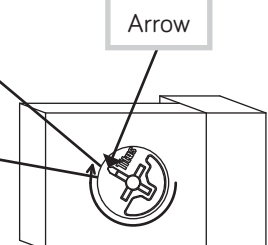

Step 5

- ✚ Insert two METAL PINS (1R) into each PINNED SHELF (G).
- ✚ Insert the METAL PINS (1R) in one end of the PINNED SHELVES (G) into the holes in the UPRIGHT (C).

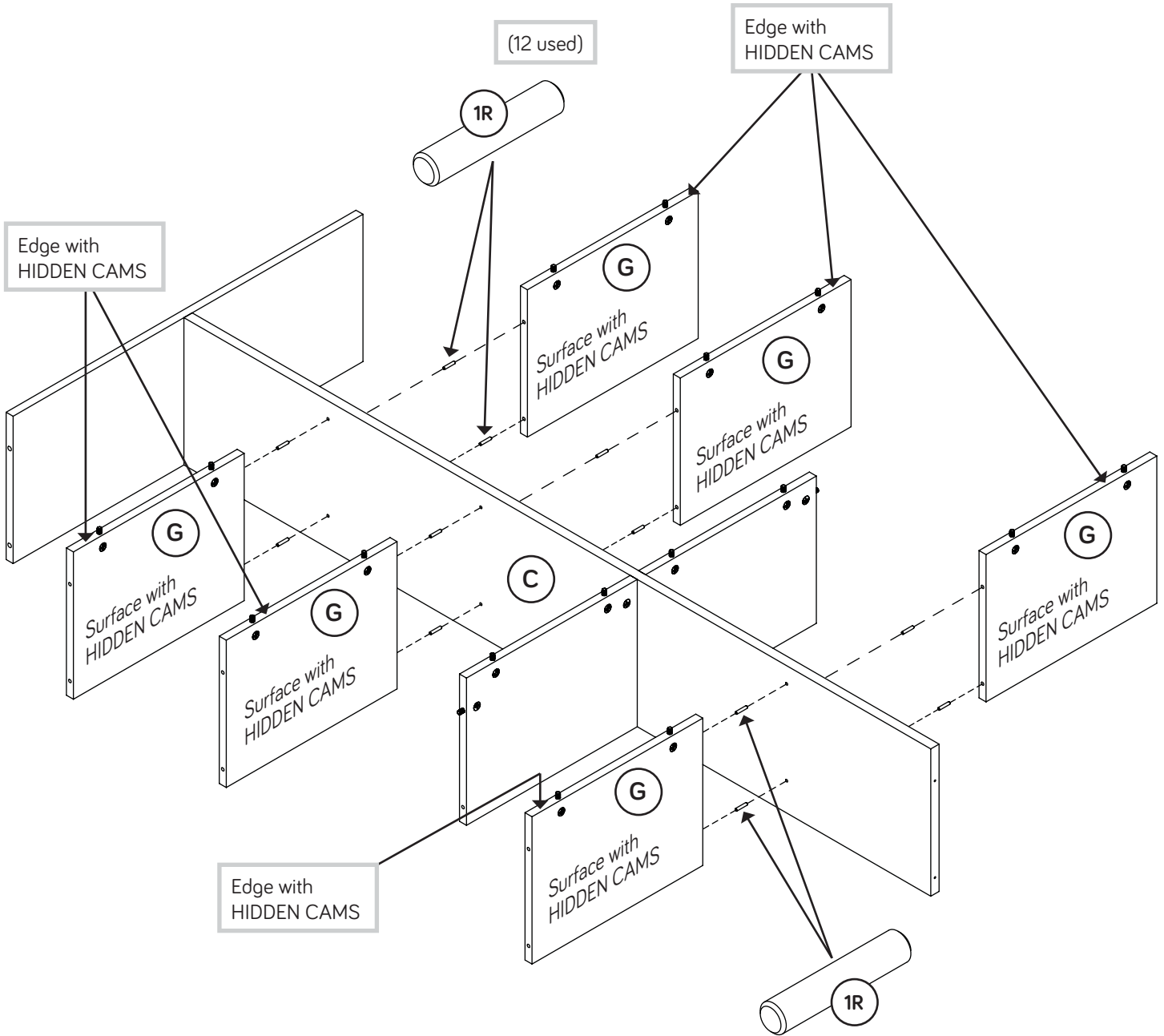

Step 6

 Fasten the BOTTOM (E) to the UPRIGHT (C). Use two BLACK 1-7/8" FLAT HEAD SCREWS (2S).

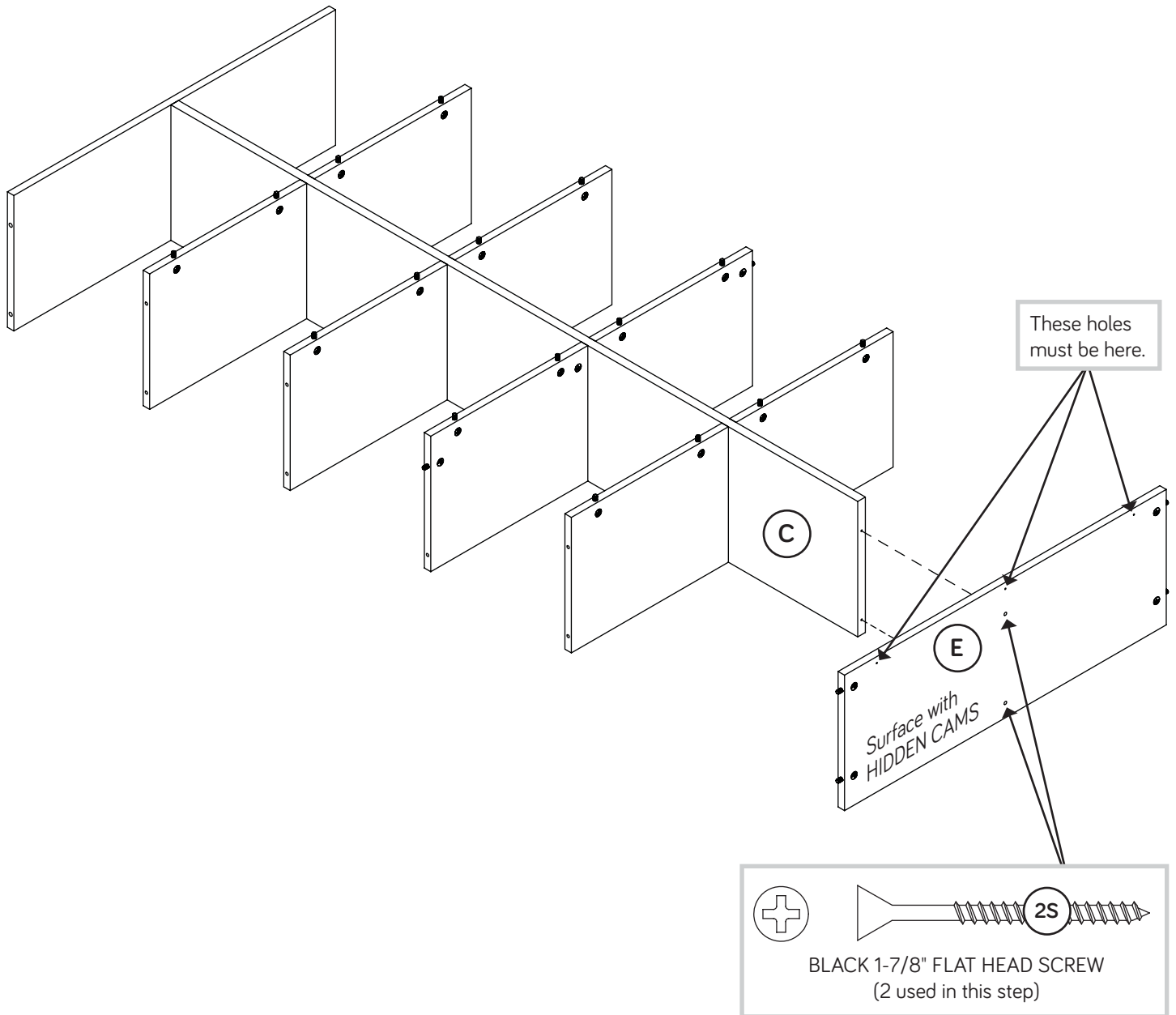

Step 8

Fasten seven METAL BRACKETS (4G) to the ENDS (A and B) and BOTTOM (E). Use seven BLACK 9/16" LARGE HEAD SCREWS (1S).

NOTE: Be sure the BRACKETS are even with the edges of the ENDS and BOTTOM.

Fasten the BASE (I) to the ENDS (A and B) and BOTTOM (E). Use seven BLACK 9/16" LARGE HEAD SCREWS (1S) through the METAL BRACKETS and into the BASE.

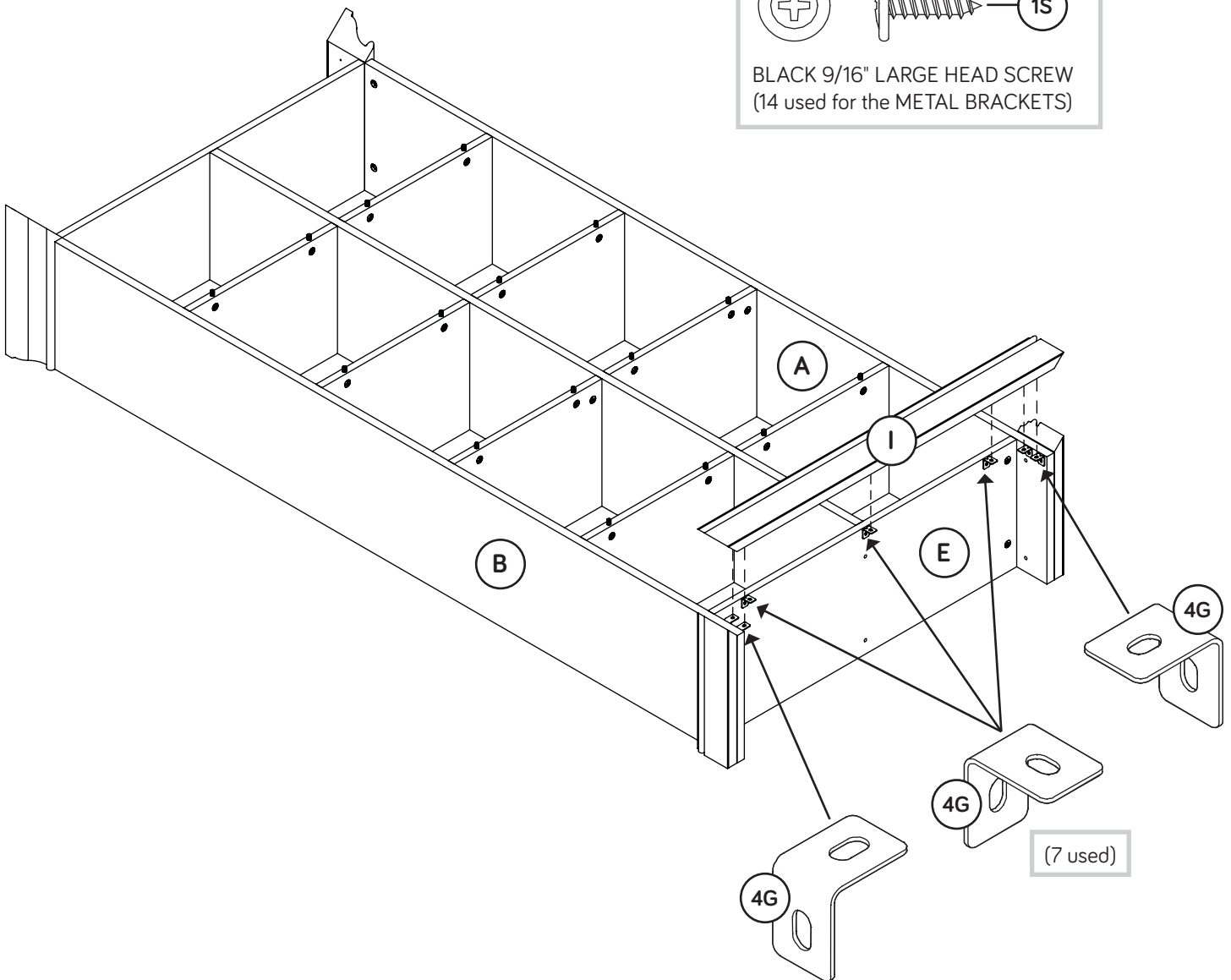
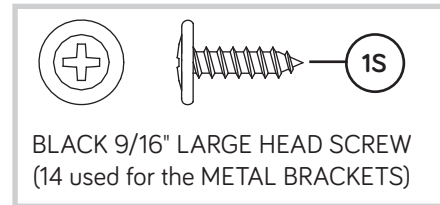

Step 9

- Fasten two CARD HOLDERS (35M) to a SHELF MOLDING (L). Use four SILVER 3/8" MACHINE SCREWS (97S).
- Repeat this step for the other CARD HOLDERS and SHELF MOLDINGS.
- Fasten the SHELF MOLDINGS (L) to the SHELVES (F and G). Tighten sixteen HIDDEN CAMS.

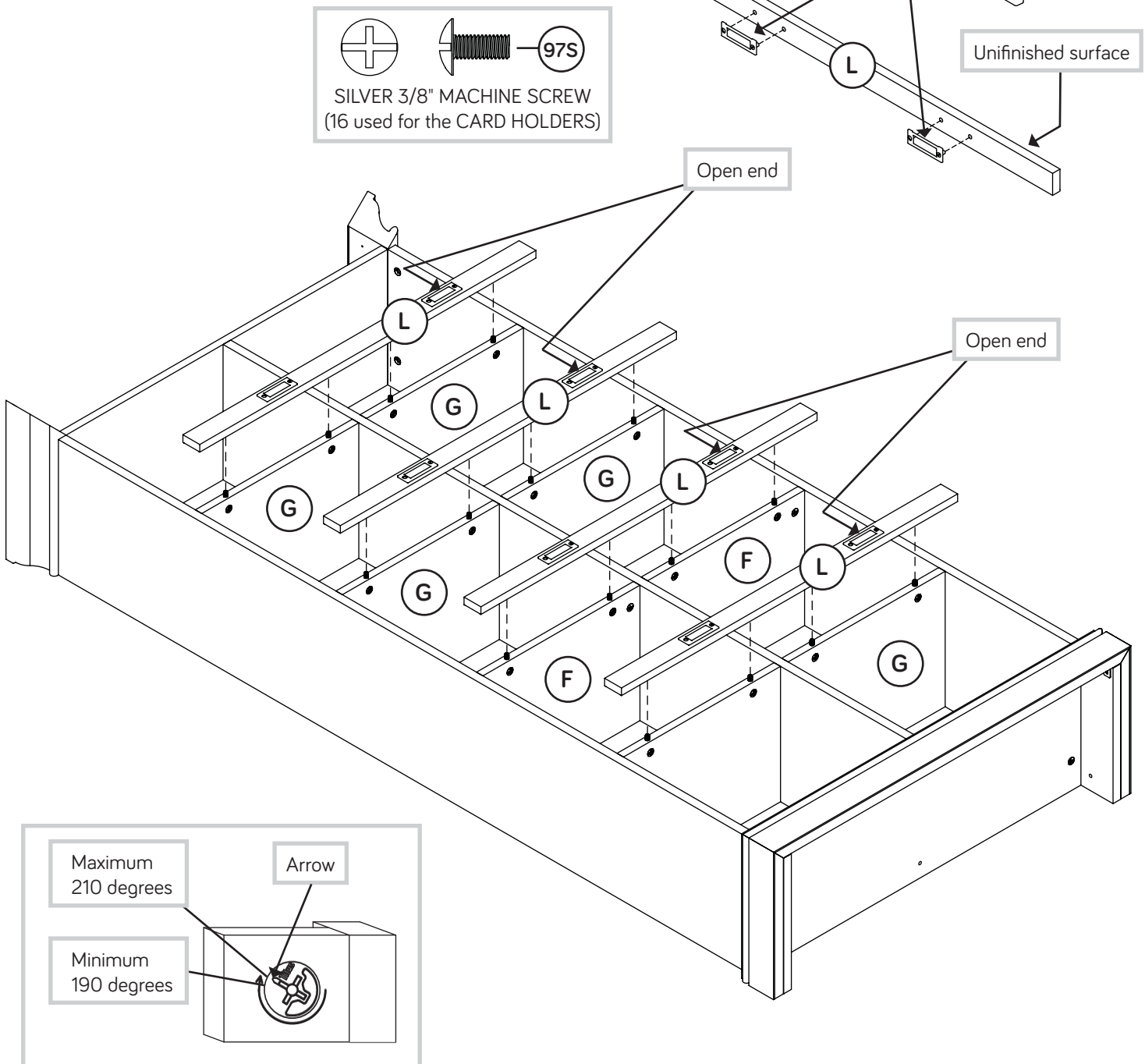

Step 10

- Fasten two CORNER BRACKETS (31G) to the MOLDINGS (N and O) and TOP (D). Use eight BLACK 9/16" LARGE HEAD SCREWS (1S).
- Fasten a METAL BRACKET (4G) to the TOP (D). Use a BLACK 9/16" LARGE HEAD SCREW (1S).
- Fasten the FRONT MOLDING (M) to the TOP (D) and MOLDINGS (N and O). Use five BLACK 9/16" LARGE HEAD SCREWS (1S) through the METAL BRACKET (4G) and CORNER BRACKETS (31G) and into the FRONT MOLDING.

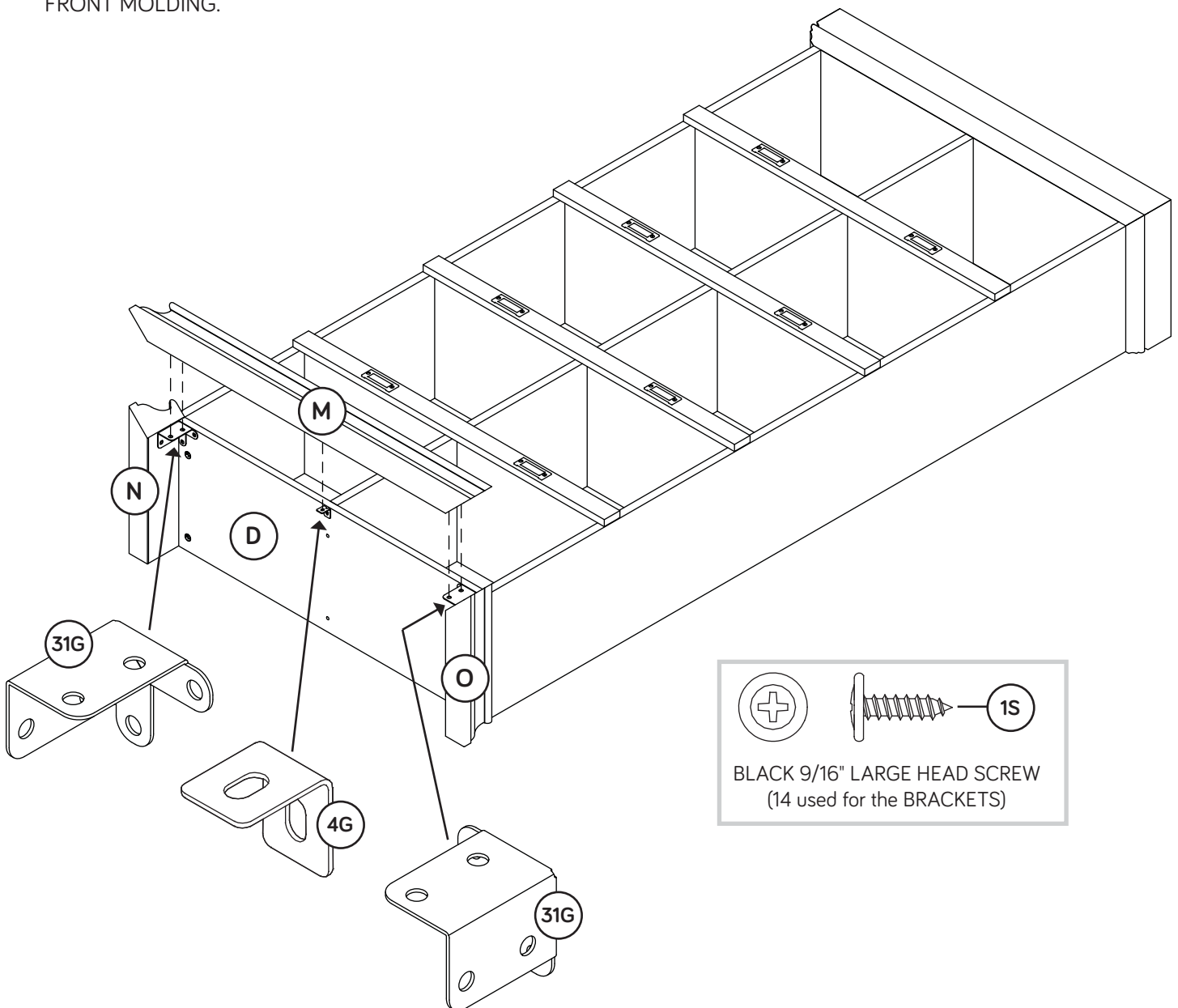

Step 11

- ✚ Carefully turn your unit over onto its front edges. Unfold the BACK (H) and lay it over your unit.
- ✚ Make equal margins along all four edges of the BACK (H). Push on opposite corners of your unit if needed to make it "square".
- ✚ Fasten the BACK (H) to your unit using the NAILS (1N).
- ✚ **NOTE:** Be sure to tap NAILS into the holes that line up over the UPRIGHT (C) and SHELVES (F and G).



Do not stand the unit upright without the BACK fastened. The unit may collapse.

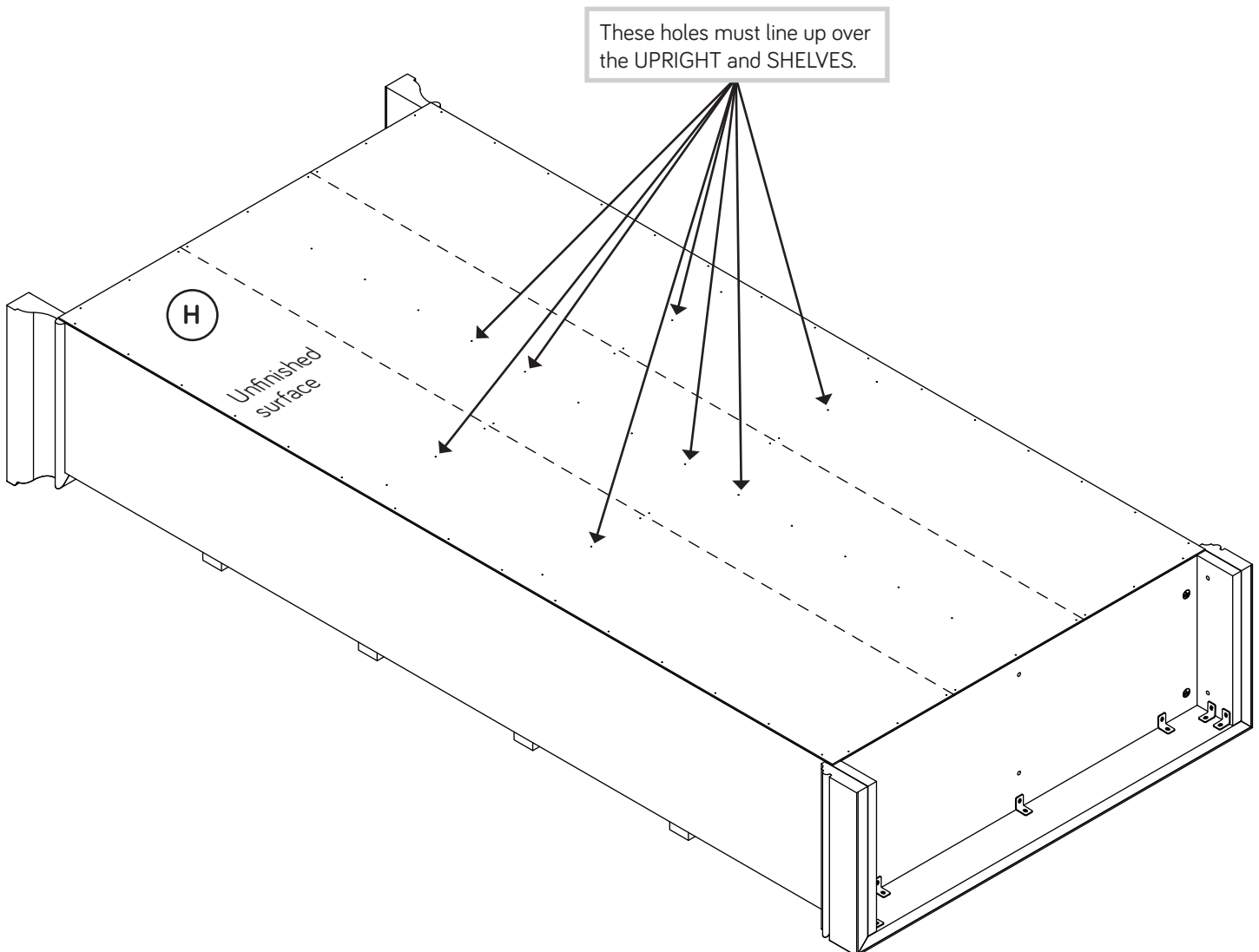
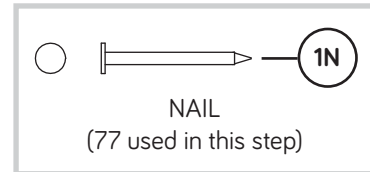

Step 12

- ✦ Carefully stand your unit upright.
- ✦ We recommend using the SAFETY BRACKET (1G) for added stability. Use a BLACK 9/16" LARGE HEAD SCREW (1S) into the top of the unit and a BLACK 1-7/8" FLAT HEAD SCREW (2S) into a stud in your wall.
- ✦ Push a CAM COVER (13P) onto each visible HIDDEN CAM.
- ✦ Separate the CARDS on the CARD SHEET (38M) and insert into the CARD HOLDERS.
- ✦ NOTE: Please read the back pages of the instruction booklet for important safety information.
- ✦ This completes assembly. Clean with your favorite furniture polish or a damp cloth. Wipe dry.

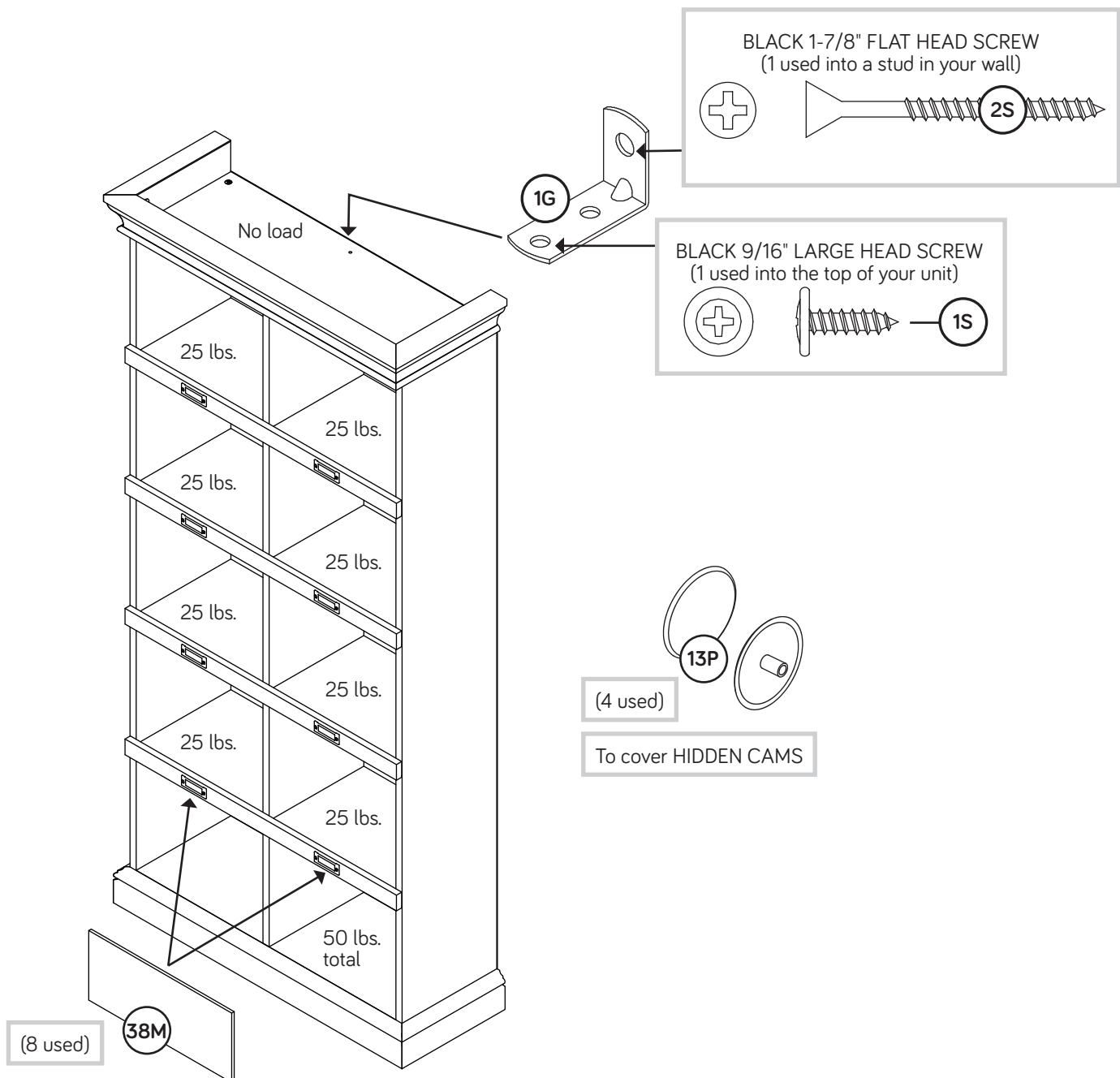

WARNING

Please use your furniture correctly and safely. Improper use can cause safety hazards, or damage to your furniture or household items. **Carefully read the following chart.**

Look out for:	What can happen:	How to avoid the problem:
<ul style="list-style-type: none">• Overloaded shelves.• Improper loading can cause the product to be top-heavy.	<ul style="list-style-type: none">• Risk of injury.• Top-heavy furniture can tip over.• Overloaded shelves can break.	<ul style="list-style-type: none">• Never exceed the weight limits shown in the instructions.• Work from bottom to top when loading shelves. Place the heavier items on the lower shelves.
<ul style="list-style-type: none">• Improperly moving furniture that is not designed and equipped with casters.	<ul style="list-style-type: none">• Furniture can tip over or break if improperly moved.• Physical injury. Furniture can be very heavy.	<ul style="list-style-type: none">• Unload shelves from top to bottom before moving the furniture.• Do not push furniture, especially on a carpeted floor. Have a friend help you lift the item and set it in place.• This unit must be positioned against a wall.
<ul style="list-style-type: none">• Children climbing on the shelves can cause the product to tip.	<ul style="list-style-type: none">• Risk of injury or death.	<ul style="list-style-type: none">• Do not allow children to climb on the shelves. Avoid placing items like toys or candy on upper shelves.• Use the supplied safety bracket for added stability.
<ul style="list-style-type: none">• Placing TVs on furniture items that are not designed to support a television is hazardous.	<ul style="list-style-type: none">• Risk of injury or death. TVs can be very heavy. Plus the weight and location of the picture tube tends to make TVs unbalanced and prone to tipping forward.	<ul style="list-style-type: none">• This product is not designed to support a television.