

BOXI towers



FEATURES

- 2 widths – 360 mm, 420 mm;
- 2 depths: 800 mm (for single desks), 820 mm (for bench desks);
- 3 heights: 740 mm, 1090 mm, 1200 mm;
- Different inner combinations.

TECHNICAL INFORMATION

Carcass

- Made of 16 mm MFC (melamine) with 1 mm edging;
- Made of 18 mm MFC (melamine) with 1 mm edging;
- Made of 25 mm MFC (melamine) with 2 mm edging (only for H=740 mm top and H=1090 mm middle top).



Handle type (colour + handle code)

Pull-out drawer

- Made of 18 mm MFC (melamine) with 1 mm edging (except file tower, and towers which are 360 mm width, there are parts which are made of 16 mm MFC (melamine));
- Soft closing function;
- Lockable;
- Load max. 50 kg;
- Plastic pen holder is integrated in the upper shelf (TBR/TBL201-202, TBR/TBL307-308).

Legs

- Four plastic height levelling feet, H=23 mm (+10 mm);
- 1 castor Ø80 mm (tread from thermoplastic rubber, non-marking).

Sliding doors (TBR/TBL303-304)

- Made of 10 mm plywood with laminate, edges – lacquered;
- No handles (just cut-outs);
- White plastic slide profile.

Inner file drawers (TBR/TBL309-310)

- Made of 12 mm MFC (melamine) with 1 mm edging;
- Full extension ball bearing slides, which are visible;
- Height – 280 mm, depth – 350 mm, width – 646 mm;
- Convenient opening without handles.



Inner personal drawers (TBR/TBL311-316)

- Made of 12 mm MFC (melamine) with 1 mm edging;
- Full extension ball bearing slides, which are visible;
- Height – 120 mm, depth – 300 mm, width – 450 mm;
- Convenient opening without handles.



Fixed metal shelves (TBR/TBL309-316)

- Made of 1 mm thick steel sheet;
- Powder coated metal;
- Fixed with screws.



USB fast charger (TBR/TBL313-314)

- A+C Twin USB Fast Charger integrated into the back panel of the cabinet;
- Hardwired power cord to GST18-3 800 mm;
- Cable length: 3 m;
- Dimensions: Ø74x50 mm;
- Cable standard: UK, EU, CH, FR, US;
- R letter means that if the port is damaged, you can change it without replacing the whole socket;
- Black plastic.

Power socket (TBR/TBL315-316)

- 1 AC power socket 100 – 230 V;
- Hardwired power cord to GST18-3 800 mm;
- Cable length: 3 m;
- Dimensions: Ø74x50 mm, hole for socket Ø60 mm;
- Power socket standards: UK, EU, CH, FR, US;
- Black plastic.

Hook for clothes

- Dimensions: 20x28, H=62 mm;
- Powder coated metal;
- Fixed with screws.

Felt-lined inserts

- For towers with metal shelves;
- 2 sizes: 671x198x2 mm, 450x343x2 mm;
- Suitable with ERA, LUCIA, VELITO PRESTO, SYNERGY;
- Optional, need to be ordered separately.

RANGE

Towers*

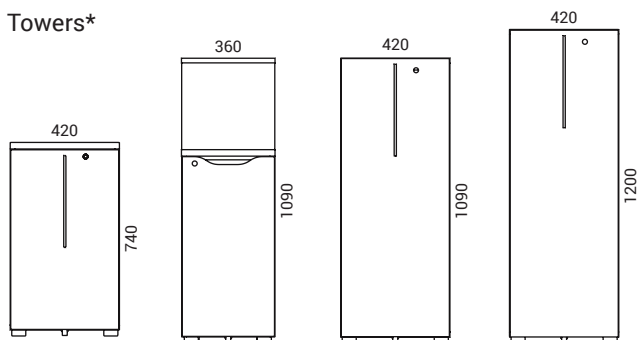

D = 800 / 820 mm

*R/H or L/H option available

Bookcase

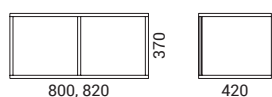

Planter Box

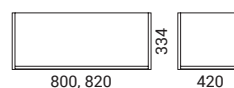

Optional



Drawer's box

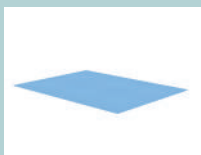

Felt-lined inserts

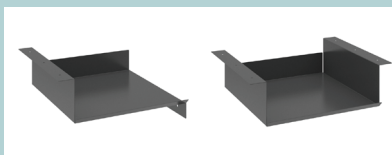

Metal shelves (right / central)



Metal hook for clothes



Master key

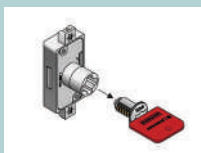

Removal key



Cylinder lock with 2 keys

ADDITIONAL INFORMATION



- Bookcase or plant box fixing. For fixing bookcase or plant box onto the tower please use stickers and follow the assembly scheme (included in the package).
- Planter box care. Please note that the inner part of planter box is not protected from the moisture. We recommend you to use the Melamine Cleaning and Care Instructions.

- Changing tower sides. You can switch the inner wall side from R/H to L/H or vice versa for universal towers - TBU301-302 and towers assembled as R/H or L/H - TBR/TBL201-202, TBR/TBL307-308. Please use the special fittings and follow the assembly scheme (included in the package).

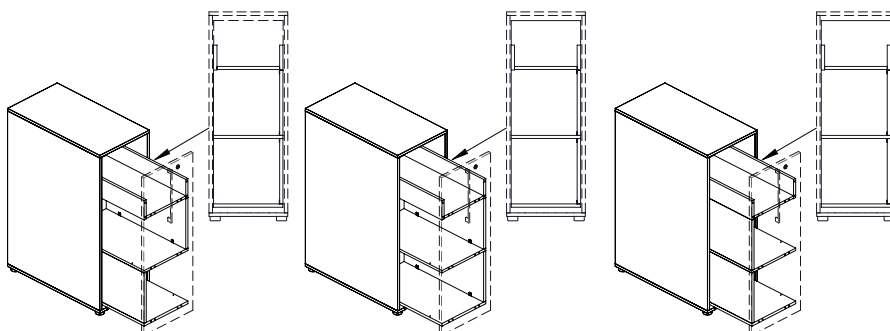

- USB port/power socket cable management.

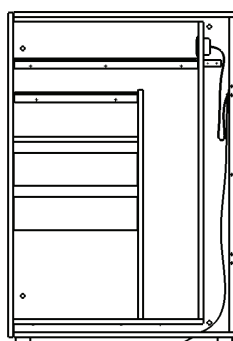

Closed

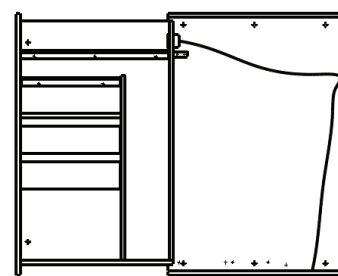

Open

Accessories fixing position

Fixing position of right metal shelf C0Z062



- TBR/TBL201-202



- TBR/TBL301-302 (suitable only for the upper shelf)



- TBU301-302



- TBR/TBL307-308*



- TBR309-310



- TBL309-310

* If you decide to switch sides from right or left, you will have to reassemble the shelves.

Fixing position of central metal shelf C0Z063



- TBR/TBL201-202



- TBU301-302



- TBR/TBL307-308*



- TBR/TBL309-310

* If you decide to switch sides from right or left, you will have to reassemble the shelves.

Fixing position of metal hook ZZZ061



- TBR/TBL311-315

Fixing position of drawer's box ZTZ005



- TBR/TBL201-202

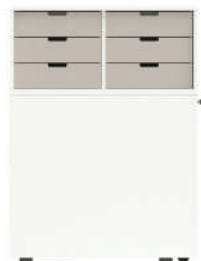

- TBR/TBL302, 304





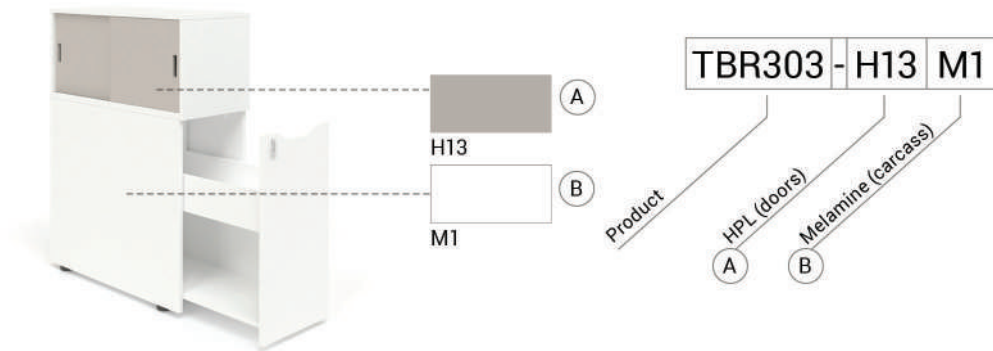
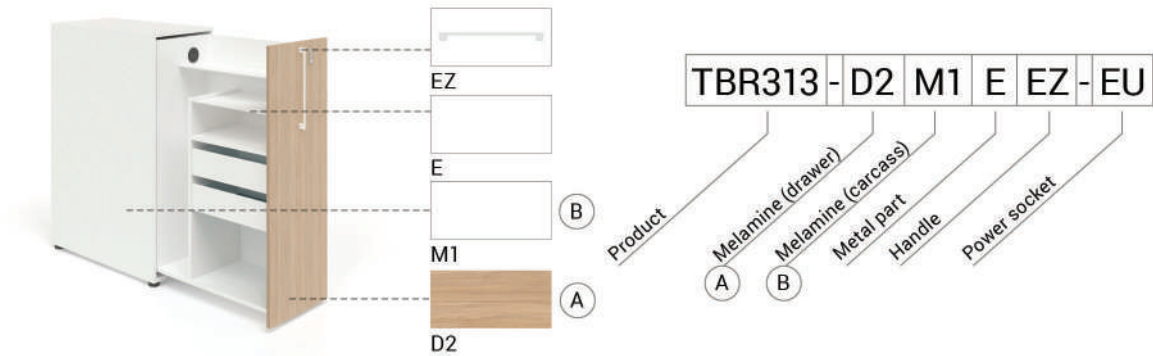

- TBU301-302

ORDERING EXAMPLE

Code structure



	Description	W	D	H	Code	Price, GBP (RRP)			
						(A) Melamine: D1 D2 D3 D4 D1 D2 D3 D4 M1 N1 D5 N2 M1 N1 D5 N2 N3 N3			
						(B) Melamine: D1 D2 M1 N1 N3 D3 D4 D5 N2			
						Handle: EZ MZ AZ T1Z			
	Tower, preassembled as R/H (lockable, with 2 shelves and pencil tray)	420	800	740	TBR201	660	664	680	692
		420	820	740	TBR202	668	680	692	708
	Tower, preassembled as L/H (lockable, with 2 shelves and pencil tray)	420	800	740	TBL201	660	664	680	692
		420	820	740	TBL202	668	680	692	708

	Description	W	D	H	Code	Price, GBP (RRP)								
						Melamine:								
						D1	D2	M1	N1	N3	D3	D4	D5	N2
	Bookcase for 800 mm length towers (without base)	800	420	370	TBE081	92					112			
	Bookcase for 820 mm length towers (without base)	820	420	370	TBE082	104					120			
	Planter box for 800 mm length towers (without base)	800	420	334	TBE083	68					84			
	Planter box for 820 mm length towers (without base)	820	420	334	TBE084	80					104			

(A) Melamine:

D1	D2	M1	N1	N3	D3	D4	D5	N2	D1	D2	M1	N1	N3	D3	D4	D5	N2
----	----	----	----	----	----	----	----	----	----	----	----	----	----	----	----	----	----

(B) Melamine:

D1	D2	M1	N1	N3	D3	D4	D5	N2
----	----	----	----	----	----	----	----	----



Tower, R/H (lockable, with bookcase on the top)

360 800 1090 TBR301

616 636 660 672

360 820 1090 TBR302

632 652 668 688



Tower, L/H (lockable, with bookcase on the top)

360 800 1090 TBL301

616 636 660 672

360 820 1090 TBL302

632 652 668 688

(A) HPL: H70 H12 H13 H14 H15

(B) Melamine:

D1	D2	M1	N1	N3	D3	D4	D5	N2
----	----	----	----	----	----	----	----	----



Tower, R/H (lockable, with sliding doors on the top)

360 800 1090 TBR303

720 776

360 820 1090 TBR304

732 792



Tower, L/H (lockable, with sliding doors on the top)

360 800 1090 TBL303

720 776







360 820 1090 TBL304



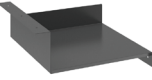

732 792

		Description	W	D	H	Code	Price, GBP (RRP)								
							(A) Melamine:								
							D1 M1 N3	D2 N1	D3 D5	D4 N2	D1 M1 N3	D2 N1	D3 D5	D4 N2	
							(B) Melamine:								
							D1	D2	M1	N1	N3	D3	D4	D5	N2
							Handle: EZ MZ AZ T1Z								
	Tower (lockable, with 3 shelves)	420	800	1090	TBU301	896	924	1000	1032						
		420	820	1090	TBU302	908	940	1016	1044						
	Tower, preassembled as R/H (lockable, with 3 shelves and pencil tray)	420	800	1200	TBR307	916	952	1024	1052						
		420	820	1200	TBR308	928	960	1036	1064						
	Tower, preassembled as L/H (lockable, with 3 shelves and pencil tray)	420	800	1200	TBL307	916	952	1024	1052						
		420	820	1200	TBL308	928	960	1036	1064						
							(A) Melamine:								
							D1 M1 N3	D2 N1	D3 D5	D4 N2	D1 M1 N3	D2 N1	D3 D5	D4 N2	
							(B) Melamine:								
							D1	D2	M1	N1	N3	D3	D4	D5	N2
							Metal part: E A								
							Handle: EZ MZ AZ T1Z								
	Tower, R/H (lockable, with 2 shelves, 1 metal shelf and file drawer)	420	800	1200	TBR309	1084	1100	1120	1132						
		420	820	1200	TBR310	1096	1108	1128	1152						
	Tower, L/H (lockable, with 2 shelves, 1 metal shelf and file drawer)	420	800	1200	TBL309	1084	1100	1120	1132						
		420	820	1200	TBL310	1096	1108	1128	1152						

	Description	W	D	H	Code	Price, GBP (RRP)			
						(A) Melamine: D1 D2 D3 D4 D1 D2 D3 D4 M1 N1 M1 N1 M1 N1 M1 N1 N3 N3 N3 N3 N3 N3 N3 N3			
						(B) Melamine: D1 D2 M1 N1 N3 D3 D4 D5 N2 Metal part: E A Handle: EZ MZ AZ T1Z			
	Tower, R/H (lockable, 1 shelf, 2 metal shelves and 2 small drawers)	420	800	1200	TBR311	1048	1064	1100	1108
		420	820	1200	TBR312	1060	1084	1108	1124
	Tower, L/H (lockable, 1 shelf, 2 metal shelves and 2 small drawers)	420	800	1200	TBL311	1048	1064	1100	1108
		420	820	1200	TBL312	1060	1084	1108	1124

						(A) Melamine: D1 D2 D3 D4 D1 D2 D3 D4 M1 N1 M1 N1 M1 N1 M1 N1 N3 N3 N3 N3 N3 N3 N3 N3			
						(B) Melamine: D1 D2 M1 N1 N3 D3 D4 D5 N2 Metal part: E A Handle: EZ MZ AZ T1Z Power socket: EU UK CH FR			
	Tower, R/H (lockable, with usb port, 1 shelf, 2 metal shelves and 2 small drawers)	420	800	1200	TBR313	1396	1412	1428	1444
		420	820	1200	TBR314	1416	1424	1436	1452
	Tower, L/H (lockable, with usb port, 1 shelf, 2 metal shelves and 2 small drawers)	420	800	1200	TBL313	1396	1412	1428	1444
		420	820	1200	TBL314	1416	1424	1436	1452

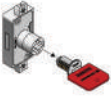
	Description	W	D	H	Code	Price, GBP (RRP)			
						(A) Melamine: D1 D2 D3 D4 D1 D2 D3 D4 M1 N1 D5 N2 M1 N1 D5 N2 N3 N3			
						(B) Melamine: D1 D2 M1 N1 N3 D3 D4 D5 N2			
						Metal part: E A			
						Handle: EZ MZ AZ T1Z			
						Power socket: EU UK CH FR			
	Tower, R/H (lockable, with power socket, 1 shelf, 2 metal shelves and 2 small drawers)	420	800	1200	TBR315	1212	1216	1248	1264
		420	820	1200	TBR316	1224	1236	1264	1276
	Tower, L/H (lockable, with power socket, 1 shelf, 2 metal shelves and 2 small drawers)	420	800	1200	TBL315	1212	1216	1248	1264
		420	820	1200	TBL316	1224	1236	1264	1276
						Fabric:			
						Lucia, Era	Synergy, Velito Presto		
	Felt-lined insert for towers with metal shelf	671	198	3	TBZ001	20	36		
	Felt-lined insert for towers with metal shelf	453	342	3	TBZ002	28	40		
						Metal: E A M T1			
	Metal hook for clothes	20	28	62	ZZZ061	16			
	Metal shelf (right)	300	300	100	C0Z062	52			
	Metal shelf (central)	300	300	100	C0Z063	64			

	Description	W	D	H	Code	Price, GBP (RRP)
						HPL: H70 H12 H13 H14 H15
						Carcass: M1
	Drawers' box	370	305	330	ZTZ005	264
						Accessories
	Master key (1 pcs.)				ZZZ058	32
	Removal key (1 pcs.)				ZZZ059	20
	Cylinder lock with 2 keys				ZZZ060	16